

MODELS:

SS850 (SS850ICLN), (SS850ICLL)

SS850 (SS850ICAN), (SS850ICAL)

SS850 (SS850FCAN), (SS850FCAL)

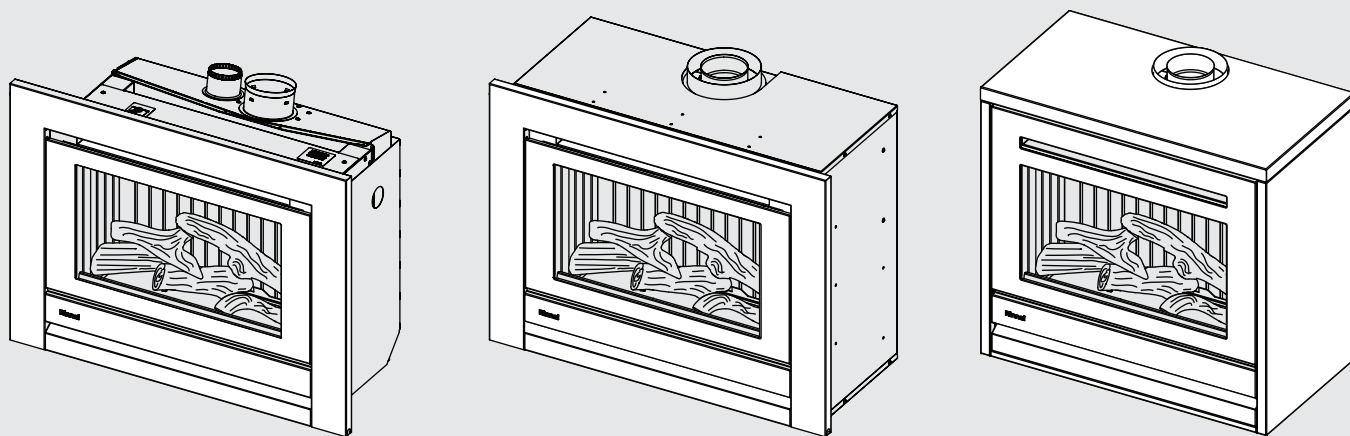

SS850 - Gas Fireplace

Operation Manual

Rinnai

Congratulations on the purchase of your Rinnai SS850 Room-Sealed Gas Fire. We trust you will have many years of comfort and enjoyment from your appliance.



BEFORE USING THIS APPLIANCE

Before proceeding with the operation of this fire, read this manual thoroughly and gain a full understanding of the appliance to ensure safe and correct use.

For details on how to install this appliance refer the Installation Manual.

This appliance must be installed in accordance with:

- Manufacturer's Installation Instructions
- Current AS/NZS 3000, AS/NZS 3500 & AS/NZS 5601
- Local Regulations and Municipal Building Codes including local OH&S requirements

This appliance must be installed, maintained and removed **ONLY** by an Authorised Person.

For continued safety of this appliance it must be installed and maintained in accordance with the manufacturer's instructions.



**The Australian
Gas Association**
All Rinnai gas products
are A.G.A. certified.

TABLE OF CONTENTS

Warnings & Important Information	4
Before Using this Appliance	4
Regulatory Information	4
Notice to Victorian Consumers	4
Dress Guard Warnings	4
Mandatory Inspection prior to Installation	4
Modifications	5
General Safety Warnings	5
Operational Safety Warnings	6
Safety Devices	7
About Your Heater	8
General Overview: Inbuilt Model SS850ICLN, SS850ICLL, SS850ICAN & SS850ICAL	8
General Overview: Freestanding Model SS850FCAN & SS850FCAL	9
Control Panel Operation	10
To Turn ON Your Heater	10
To Turn OFF Your Heater	10
Interruption to Electricity or Gas Supply During Operation	10
Restart Procedure After Interruption to Electricity Supply	10
Full Control and Partial Control	10
Remote Control Operation	11
Remote Control Activation	11
Button Functions, Display & Operation	11
Lost, Misplaced or Broken Remote Control	11
Battery Safety	12
Changing the Batteries	12
Care & Maintenance	13
Error Codes	13
Cleaning	14
Normal Operational Characteristics	14
Trouble Shooting	14
Trouble Shooting Checklist	15
Service	15
Abnormal Flame Pattern	16
CR2450 Button Batteries	16
Installation Record	17
Contacts	20

WARNINGS & IMPORTANT INFORMATION



BEFORE USING THIS APPLIANCE

Before proceeding with the operation of this fire, read this manual thoroughly and gain a full understanding of the appliance to ensure safe and correct use.

Failure to carefully read and follow all instructions in this manual can result in equipment malfunction, fire or explosion, property damage, personal injury and/or death.

DANGER: Indicates an imminently hazardous situation which, if not avoided, will result in personal injury or death.

WARNINGS: Indicates a potentially hazardous situation which, if not avoided, could result in personal injury or death.

CAUTIONS: Indicates a potentially hazardous situation which, if not avoided, could result in minor or moderate injury or damage to the appliance. It may also be used to alert against unsafe practices.



REGULATORY INFORMATION

This appliance shall be installed in accordance with:

Manufacturer's Installation Instructions.

Current AS/NZS 3000, AS/NZS 3500 & AS/NZS 5601.

Local Regulations and Municipal Building Codes including local OH&S requirements.

This appliance has been certified by the Australian Gas Association. The A.G.A. Certification Number is shown on the data plate.

This appliance **MUST** be installed, maintained and removed **ONLY** by an Authorised Person.

For continued safety of this appliance it **MUST** be installed and maintained in accordance with the manufacturers instructions.

NOTICE TO VICTORIAN CONSUMERS

This appliance **MUST** be installed by a person licensed with the Victorian Building Authority. **ONLY** a licensed person will have insurance protecting their workmanship.

So make sure you use a licensed person to install this appliance and ask for your Compliance Certificate. For further information contact the Victorian Building Authority on 1300 815 127.



DRESS GUARD WARNINGS

The guard is fitted to this appliance to reduce the risk of fire or injury from burns and no part of it should be permanently removed. For protection of young children or the infirm, a secondary guard is required.

The wire mesh dress guard supplied with this appliance **MUST NOT** be permanently removed as it fulfils an operational safety function. Additional dress guards including free standing types may be used in conjunction with, but **NOT** replace, the dress guard supplied with this appliance.



MANDATORY INSPECTION PRIOR TO INSTALLATION

Unpack the heater and check for damage. Immediately report any damage or discrepancies to the Supplier of the appliance. This appliance was inspected and tested at the time of manufacture and packaging, and released for transportation without known damage. Upon receipt, inspect the exterior for evidence of rough handling in shipment. Ensure that the appliance is labelled correctly for the gas and electrical supply, and/or other services it is intended to be connected to.

For safety and warranty purposes, appliances that may be damaged or incorrect must not be installed or operated under any circumstances. Installation of damaged or incorrect appliances may contravene local government regulations. Rinnai disclaims any liability or responsibility whatsoever in relation to the installation or operation of damaged or incorrect appliances.

Take care when opening or unpacking this appliance. Failure to do so may result in serious injury or product failure.

Check the label for the correct gas type (refer rating plate, inside the appliance). Refer to local gas authority for confirmation of the gas type if you are in doubt.

**MODIFICATIONS.****DO NOT MODIFY THIS APPLIANCE.**

Modifying from original specifications may create a dangerous situation and will void your warranty. Failure to comply with these instructions could result in a fire or explosion, which could cause serious injury, death or property damage.

DO NOT modify the electrical wiring of this appliance.

If the power cord is damaged or deteriorated it **MUST** be replaced by an authorised person. Failure to do so may result in electric shock, fire, serious injury or product failure.

Improper installation, adjustments, service or maintenance can cause serious injury, death or property damage. Such work **MUST ONLY** be performed by an authorised person.

**GENERAL SAFETY WARNINGS**

This appliance is **HEAVY**, during installation the use of a mechanical lifting aid is recommended, noting that improper lifting may result in serious injury.

WARNING: This heater **MUST NOT** be used if any of the glass panels are damaged.

Flue terminal **MUST** always vent directly to outdoors. **DO NOT** extend the flue vertically or horizontally in ways other than prescribed in this appliance manufacturer's installation instructions. **ONLY** the flue components specified by Rinnai **MUST** be used.

When considering installation ensure minimum clearances are adhered to.

Heat radiating from the front of this heater may over time affect the appearance of some materials used for flooring such as carpet, vinyl, cork or timber. This effect may be amplified if the air in the room contains cooking vapours, candle vapours and cigarette smoke, etc. Refer to the installation manual for mantle clearances, additional installation information and warnings.

This appliance **MUST NOT** be installed where curtains or other combustible materials could come into contact with it. In some cases curtains may need restraining.

This appliance is **NOT** intended for use by persons (including children) with reduced physical, sensory or mental capabilities or lack of experience and knowledge, unless they have been given supervision or instruction concerning use of the appliance by a person responsible for their safety.

The appliance is **NOT** intended for use by young children or infirm persons without supervision. Young children and the infirm **SHOULD** be supervised at all times when in the vicinity of this heater while it is in operation.

The heater **MUST NOT** be located immediately below a power socket outlet.

A dedicated 230 V earthed 10 Amp power point must be used with this appliance.

Refer to local gas authority for confirmation of the gas type if you are in doubt.

Suitable **ONLY** for indoor installation.

DO NOT operate this appliance before leak checking hoses and gas connections.

This heater **MUST NOT** be used if any of the glass panels are damaged.

NOT to be connected to an LP gas cylinder located indoors.

Please keep this instruction booklet in a safe place for future reference. All dimensions referred to in these instructions are in millimetres, unless otherwise specified.

OPERATIONAL SAFETY WARNINGS

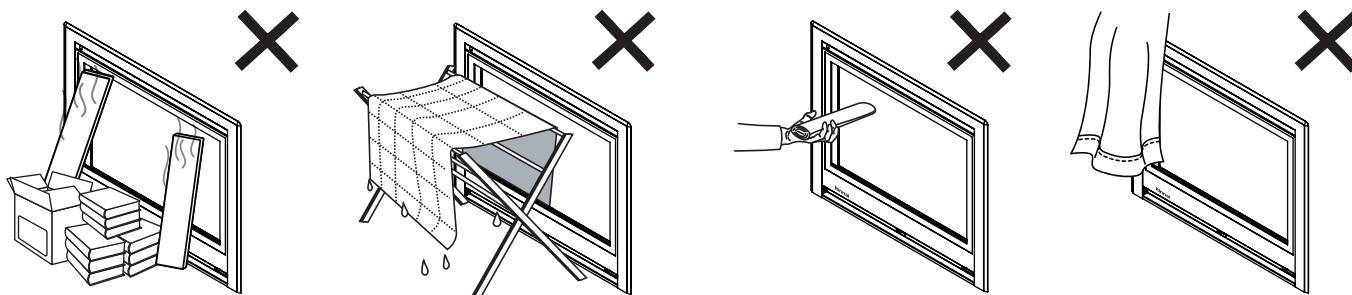

DO NOT restrict the warm air discharge or place articles on or against this appliance.

This appliance **MUST NOT** be used for any purpose other than heating.

DO NOT allow anyone to post articles through the louvres.

DO NOT let flammable and combustible materials (such as curtains, etc.), to come into contact with the heater.

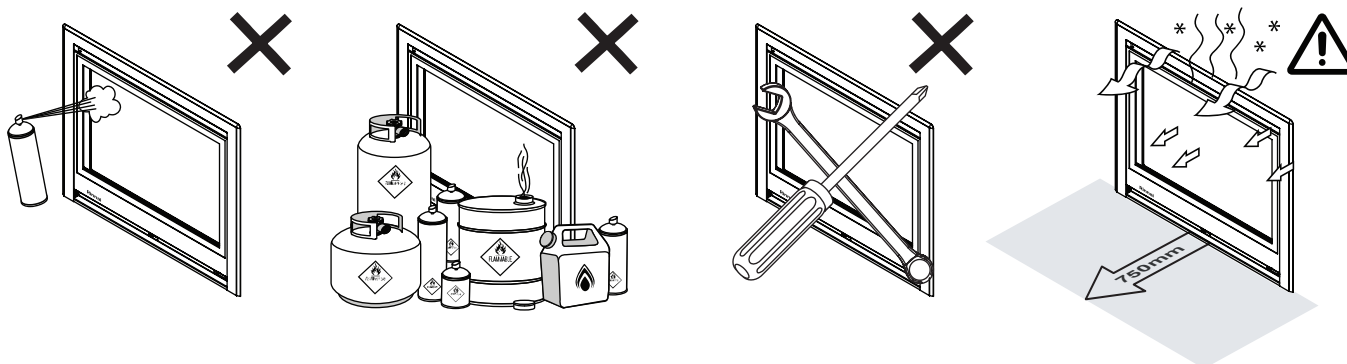

DO NOT spray aerosols in the vicinity of this appliance whilst the heater is operating. Most aerosols contain flammable gas, which can be a fire hazard if used near the heater when it is in use.

DO NOT use or store flammable materials near this appliance.

DO NOT modify this appliance.

Heat emanating from the front of the appliance may over time affect the appearance of some materials used for flooring such as carpet, vinyl, cork or timber. This effect may be amplified if the air in the room contains cooking vapours or cigarette smoke. To avoid this possibility, it is recommended that a mat be placed in front of the appliance, extending at least 750 mm in front of the heater.

When the heater is operated for the first time or after long periods of non use a slight odour may be emitted, this is normal. However if odours persist switch 'OFF' the appliance and contact Rinnai.

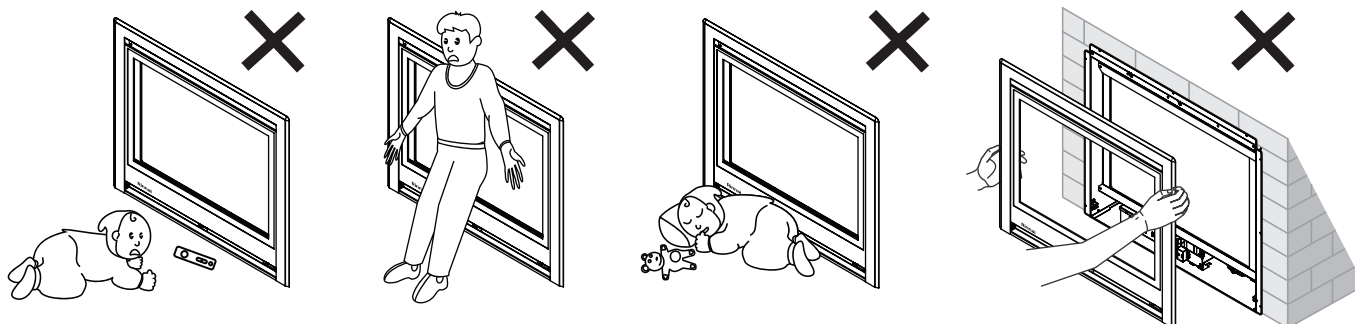

Young children should be supervised at all times. Hand or body contact with the warm air discharge louvres and glass must be avoided.

DO NOT allow anyone to sit on or lean against the appliance.

DO NOT allow young children or the infirm to sleep directly in front of the heater while in operation.

DO NOT remove the Fascia / Dress Guard. The Fascia / Dress Guard is fitted to this appliance to reduce the risk of fire or injury from burns and no part of it should be permanently removed. For protection of children or the infirm, a secondary guard is recommended.

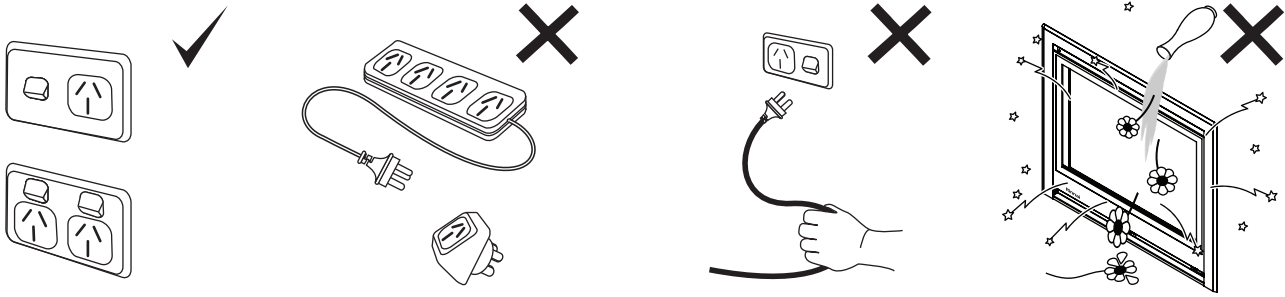

A dedicated 230V earthed 10 Amp power point **MUST BE USED** with this appliance.

DO NOT use power boards or double adaptors to operate this appliance. The heater **MUST NOT** be located below a power socket-outlet.

DO NOT unplug the heater while it is in operation or while the fan is still cycling.

DO NOT place containers of liquid above the heater. Water spillage can cause extensive damage to the appliance and create an electrocution hazard.

DO NOT place articles on or against this appliance.

DO NOT connect to an LPG gas cylinder indoors.

Turn the heater 'OFF' after use.

SAFETY DEVICES

Initial start-up

This heater has a one-time start up cycle. Should there be a fault in the heater no more than 3 manual restarts should be attempted. If the heater still fails to operate a service call will be required. Refer to the "CARE AND MAINTENANCE" pages; 12 through 15 for further information.

Over Heat Thermistor

Should the heater get too hot during operation, (for example when the air outlet louvres are blocked), this device will automatically turn the gas off and allow the heater to be manually restarted, (automatic re-start will not occur). Refer to the "CARE AND MAINTENANCE" pages; 12 through 15 for further information.

Over heat Thermal Fuse

In the unlikely event of the Over Heat Thermistor failing or some other fault occurring the Over Heat Thermal fuse will operate completely shutting the appliance down. This device is a 'one shot' only function, a service call will be required to reinstate operational ability to your heater. Refer to the "CARE AND MAINTENANCE" pages; 12 through 15 for further information.

Power Failure

Refer to page 10. In the event of power failure or power disruption your heater will shut down completely, manual restarting will be required. Refer to the "CARE AND MAINTENANCE" pages; 12 through 15 for further information.

Electric Fuse

The electrical circuits are protected by a fuse. Refer to the "CARE AND MAINTENANCE" pages; 12 through 15 for further information.

Flame Failure Sensing System

These devices within the appliance automatically cut of the gas supply to the burners in the event of a flame failure. Refer to the "CARE AND MAINTENANCE" pages; 12 through 15 for further information.

Pressure Relief

The glass panel is secured to the burner box via spring loaded pressure relief fasteners.

ABOUT YOUR HEATER

GENERAL OVERVIEW: INBUILT MODEL SS850ICLN, SS850ICLL, SS850ICAN & SS850ICAL

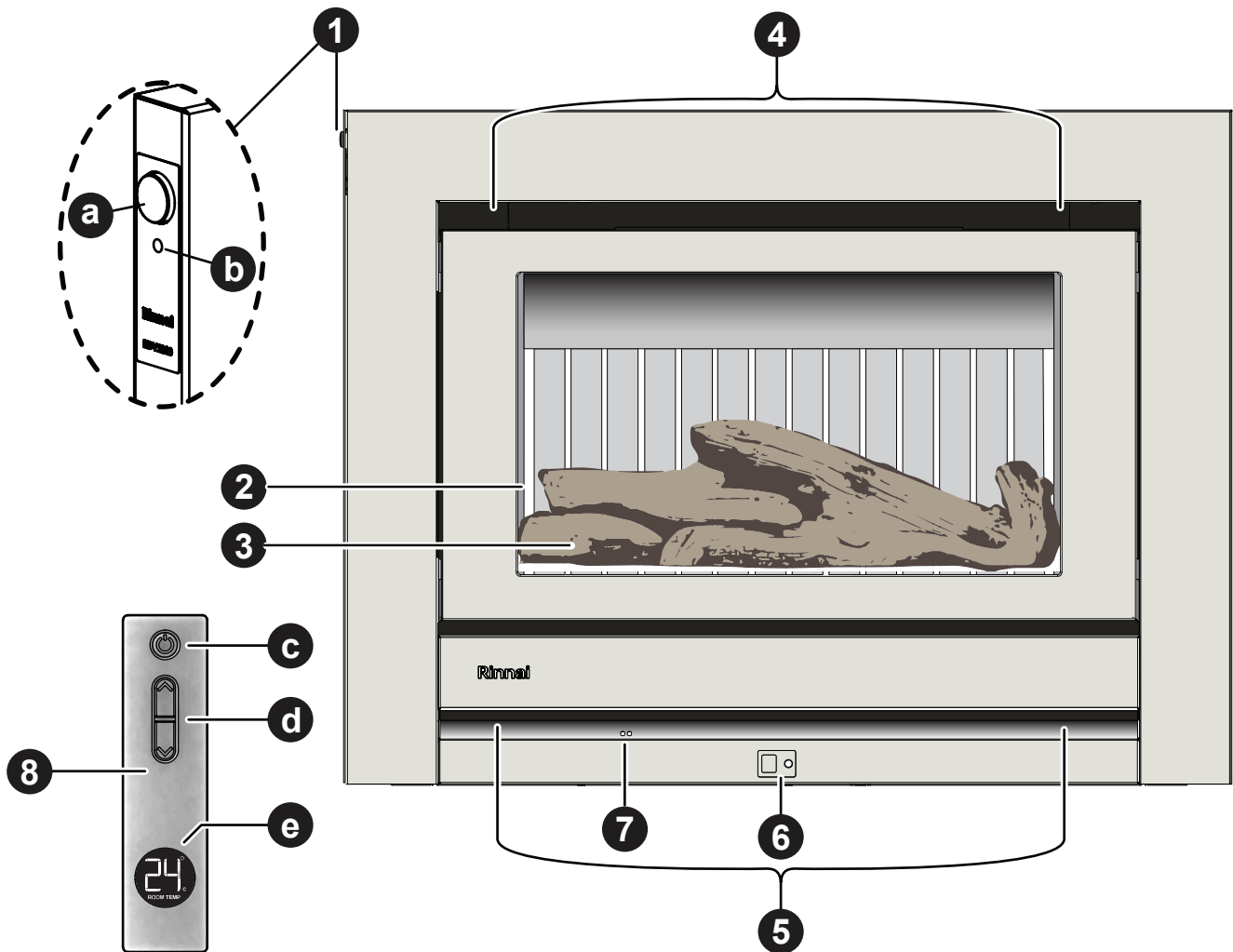

- | | |
|---|--|
| <p>1 Push button control panel</p> <p>a ON / OFF button</p> <p>b Standby / ON button:</p> | <p>Controls appliance operation between Standby and ON modes.</p> <p>Controls appliance operation between ON and OFF.</p> <p>See "Remote Control Operation" on page 11</p> |
| <p>2 Mesh dress guard (as part of fascia)</p> | |
| <p>3 Flame window</p> | <p>Ceramic log set and burner media</p> |
| <p>4 Warm air discharge vent</p> | |
| <p>5 Return air vent</p> | |
| <p>6 Remote (IR) control receiver window</p> | <p>(Green Indicator) Flashes during the pilot ignition and glows solid when pilot is established, going out once heating operation commences. Flashes to acknowledge remote control inputs.</p> |
| <p>7 Viewing window for error code display</p> | <p>Located behind the fascia. See "Error Codes" on page 13</p> |
| <p>8 Remote (IR) Control</p> <p>c Standby / ON button:</p> <p>d Flame Up / Down buttons:</p> <p>e Room temperature display</p> | <p>See "Remote Control Operation" on page 11.</p> <p>See "Remote Control Operation" on page 11.</p> <p>Displays the current temperature of the room in which the control is located. See "Remote Control Operation" on page 11.</p> |

GENERAL OVERVIEW: FREESTANDING MODEL SS850FCAN & SS850FCAL

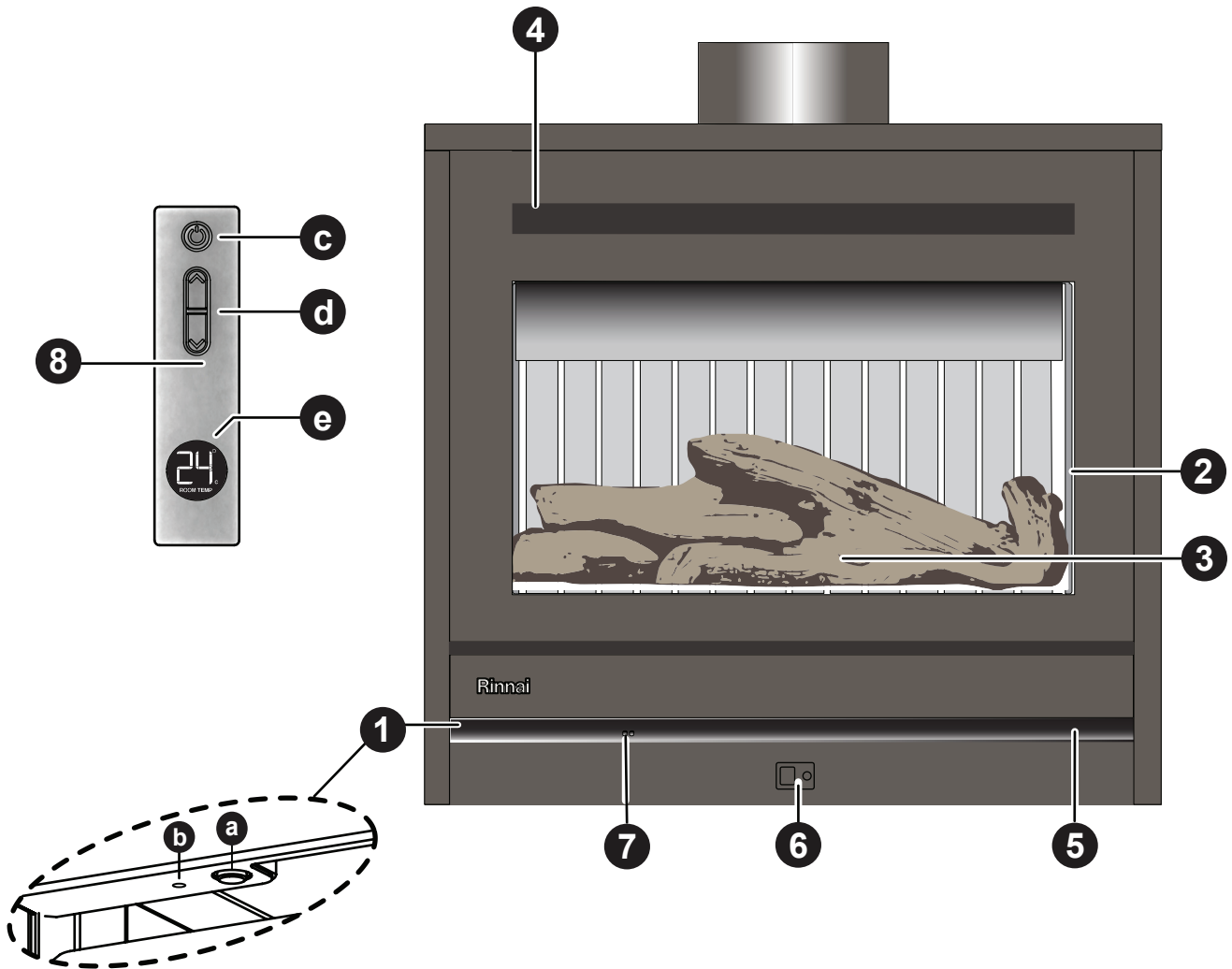

- 1 Push button control panel** Controls appliance operation between Standby and ON modes.

 - a **ON / OFF button** Controls appliance operation between ON and OFF..
 - b **Standby / ON button:** See "Remote Control Operation" on page 11.
- 2 Mesh dress guard (as part of fascia)**
- 3 Flame window** Ceramic log set and burner media.
- 4 Warm air discharge vent**
- 5 Return air vent**
- 6 Remote (IR) control receiver window** (Green Indicator) Flashes during the pilot ignition and glows solid when pilot is established, going out once heating operation commences. Flashes to acknowledge remote control inputs.
- 7 Viewing window for error code display** Located behind the fascia. See "Error Codes" on page 13
- 8 Remote (IR) control**

 - c **Standby / ON button:** See "Remote Control Operation" on page 11.
 - d **Flame Up / Down buttons:** See "Remote Control Operation" on page 11.
 - e **Room temperature display** Displays the current temperature of the room in which **the control** is located. See "Remote Control Operation" on page 11.

CONTROL PANEL OPERATION

TO TURN ON YOUR HEATER



BEFORE PROCEEDING ENSURE THE GAS AND ELECTRICITY ARE TURNED ON.

When the heater is in the OFF condition (the power supply connected and switched ON but the heater turned OFF) the Red Power Indicator — will be extinguished. This is normal.

Access the 'Push Button Control Panel' ① This is located on the front of the heater at the lower left hand corner on freestanding models and at the upper left hand side of inbuilt models.

Step 1. Press ON / OFF button (A) once. You will be able to hear the ignition sparking.

Step 2. The sparking ignition stops when the pilot flame has been established. The main burner then ignites off the pilot flame and is automatically preset to Stage 5 - High Flame. The red indicator LED (B) will illuminate.

INBUILT FIRE CONTROLS

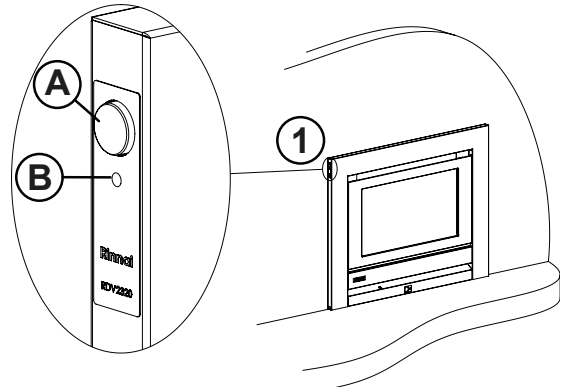

FREE STANDING FIRE CONTROLS

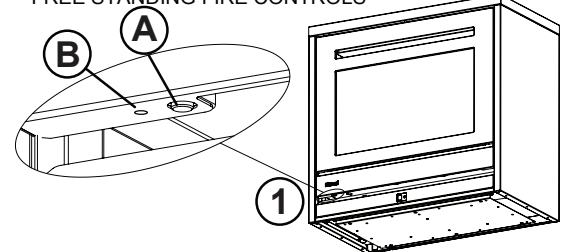

FLAME HEIGHT AND FAN SPEED

The relationship between the flame height and fan speed are preset and can not be independently adjusted.

Flame Height	1	2	3	4	5
Fan Speed (2 speed only)	Low	Low	Low	High	High

TO TURN OFF YOUR HEATER

To turn the heater 'OFF' press the Standby / ON button (B) once, when the heater is in the OFF state the Red Power Indicator will be extinguished.

INTERRUPTION TO ELECTRICITY OR GAS SUPPLY DURING OPERATION

Interruption to the power or gas supply will turn your heater OFF, upon resumption of the services the appliance will need to be restarted. This is a safety feature designed to ensure that un-attended starts do not occur after power or gas interruptions.

RESTART PROCEDURE AFTER INTERRUPTION TO ELECTRICITY SUPPLY

To restart your heater once power has been restored follow the steps for "To Turn ON Your Heater" as above.

FULL CONTROL AND PARTIAL CONTROL

Full operation of the heater is only possible by using the remote control. In the event of a misplaced or broken remote control or if the batteries for the remote control are flat, this appliance may still be operated in a limited capacity by using the power ON/OFF button (A) of the 'Push Button Control Panel' ① as described above.

The heater will automatically modulate between flame settings to maintain the default set temperature of 22°C.

No additional control of the flame or heat output is possible via the appliance ON/OFF button.

REMOTE CONTROL OPERATION

REMOTE CONTROL ACTIVATION

The remote is supplied with two Lithium cell CR2450 button batteries already pre-inserted.

To activate pull the clear tab (K), noting that **OK** will briefly be shown on the digital display (I), to confirm that the activation was successful. Noting that this also occurs when ever a fresh set of batteries is installed.

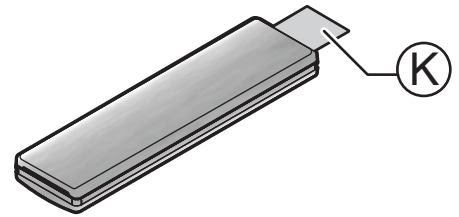

Remove the batteries if the remote is not used for extended periods. This will avoid damage from leaking batteries. If leakage has occurred the remote will need to be replaced as the chemicals could be a risk if touched or ingested.

When the controller buttons are pressed the green indicator located in the IR receiver window (C) will flash and 'Beeps' will be emitted to confirm that control inputs are being received, this indicates your remote control is now working.

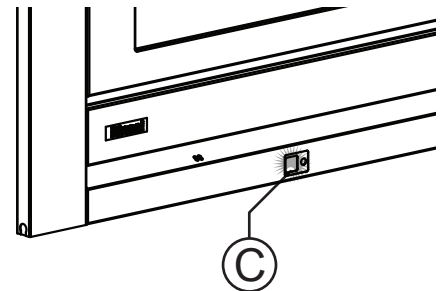

BUTTON FUNCTIONS, DISPLAY & OPERATION



For the remote control to be able to function, the appliance Standby / ON button (B) must be in the "ON" condition. Using the remote control to turn OFF the heater will place the heater into STANDBY mode.

The Standby / ON button (C) switches the heater between the Standby and ON modes.

The UP / DOWN buttons (H) control the height of the flame and heat output in five adjustment levels in fixed combination with two fan speeds.

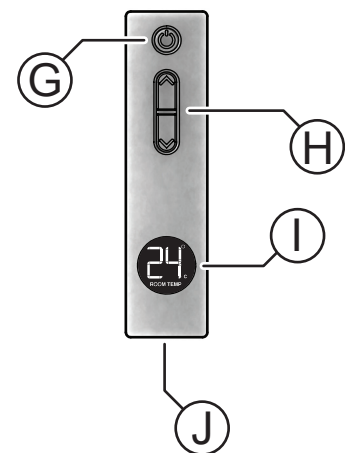

FLAME HEIGHT AND FAN SPEED

The relationship between the flame height and fan speed are preset and can not be independently adjusted.

Flame Height	1	2	3	4	5
Fan Speed (2-speed only)	Low	Low	High	High	High



On initial start-up the appliance default flame height setting is 5 - High. The flame height may only be adjusted after at least 30 seconds of operation.

The remote control temperature sensor (J) (located on the base of the controller) reads the temperature of where the remote control is currently located.

The remote controls digital display (I) shows the temperature (in degrees Celsius) of the room that the remote control is located in. It has a motion activated back light which will remain illuminated for approximately 5 seconds after a movement is sensed or when a button is pressed. Frequent illumination of the back light greatly reduces the remote control's operational battery life. To increase battery life, ensure that unnecessary illumination of the display is avoided.

LOST, MISPLACED OR BROKEN REMOTE CONTROL



Breakage of the plastic housing could expose sharp edges, replace the remote if this occurs.

Avoid getting the remote wet as water entry will damage the remote.



In the event that the remote control operation is not available, this appliance may then still be operated in a limited capacity by using the heater's control panel.

Refer to "Control Panel Operation" on page 10 for details on how to use the appliance in this mode and the limitations of this form of operation.

BATTERY SAFETY



WARNING KEEP BATTERIES OUT OF REACH OF CHILDREN.

- Swallowing may lead to serious injury in as little as 2 hours or death, due to chemical burns and potential perforation of the oesophagus.
- If you suspect your child has swallowed or inserted a button battery immediately call the 24-hour Poisons Information Centre on **13 11 26** for fast, expert advice.
- Examine devices and make sure the battery compartment is correctly secured, e.g. that the screws or other mechanical fasteners are tight. **DO NOT** use if compartment is not secure.



- Dispose of used button batteries immediately and safely. Flat batteries can still be dangerous and may be a choking hazard.
- Inform others about the risk associated with button batteries and how to keep their children safe.
- Remove the batteries if the remote is not going to be use for prolonged periods. This will help prevent damage from leaking batteries. If leakage has occurred and corrosion is evident the remote will need to be replaced.
- Leaking chemicals are toxic and **MUST NOT** be touched or ingested.
- **NEVER** mix old and new batteries.
- **DO NOT** immerse the remote control in any liquid, this will damage the remote control, rendering it inoperable and voiding its warranty.

CHANGING THE BATTERIES



When the low power symbol (left) appears at the top of the room temperature display ① the batteries are near to being fully discharged and may no longer able to power the remote control properly. Replacement of batteries is now a priority.

1. Using a suitable lever carefully remove the back cover, do this by first prying the cover off using the notch at the temperature sensor ② end as a starting point, and continuing until the cover pops off.

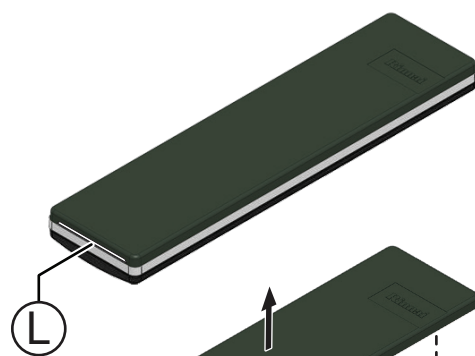

When removing the remote control cover some patience may be required as the cover is designed to be not easily removed, this is to prevent easy access to the batteries, especially by young children.

2. Once the cover is off remove the two screws ③ that secure the plastic retaining bridge ④, using a small (No.0) Phillips head screw driver or equivalent and then remove the plastic retaining bridge ④.
3. Remove the old button batteries ⑤ by carefully sliding them one at a time out from under the metal battery retainers ⑥, and into the space that was created when the plastic retaining bridge ④ was removed in the previous step.
4. Insert two new button batteries (CR2450) ⑤, under the metal battery retainers ⑥ ensuring that the positive “+” terminals (the side with the writing and the positive symbol) are facing upwards.
5. Re-fit the plastic retaining bridge ④ securing it back in place with the two screws ③.
6. With the batteries secured re-attach the rear cover by carefully clipping it back into place, noting that the end with the notch in it is at the bottom.

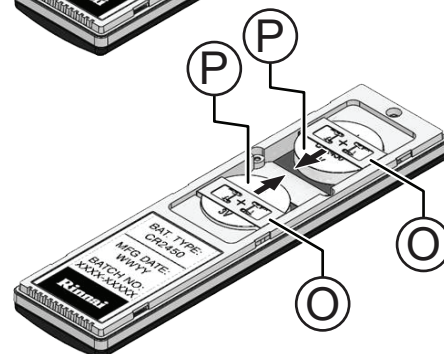
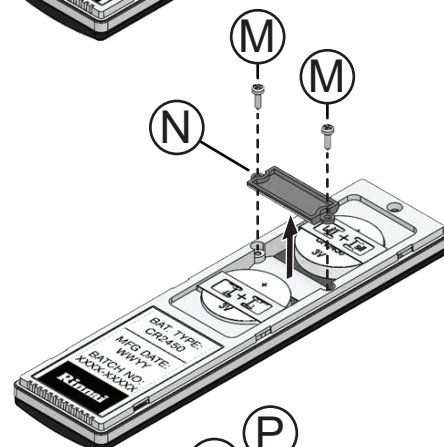
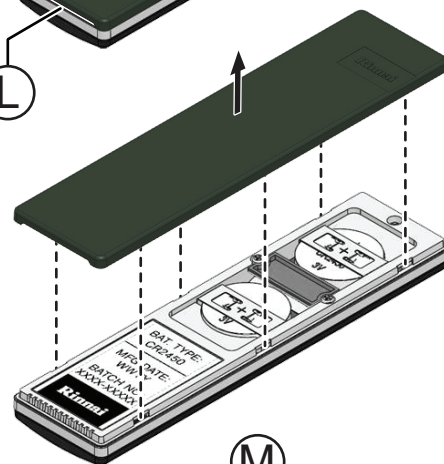

Noting that **OH** (OK) will briefly be shown on the digital display to confirm that the batteries have been successfully replaced.



Remember to dispose of used button batteries immediately and safely.

CARE & MAINTENANCE

ERROR CODES



In all cases, you should be able to clear the Error Code on display simply by turning the heater 'OFF', then 'ON' again. If the Error Message still remains or returns on the next operation, contact Rinnai or your nearest service agent and arrange for a service call.

Your Rinnai Gas Fire is also fitted with self diagnostic electronics that monitor the appliance during start-up and operation.

Should a fault occur the appliance will then shut down. The fault that has caused the shut down will be indicated by a pair of flashing digits in the Error Display window ❶ located behind the fascia. This can be viewed by looking down between the glass of the dress guard and the burner box.

Refer to the table below for probable cause and the suggested corrective action.

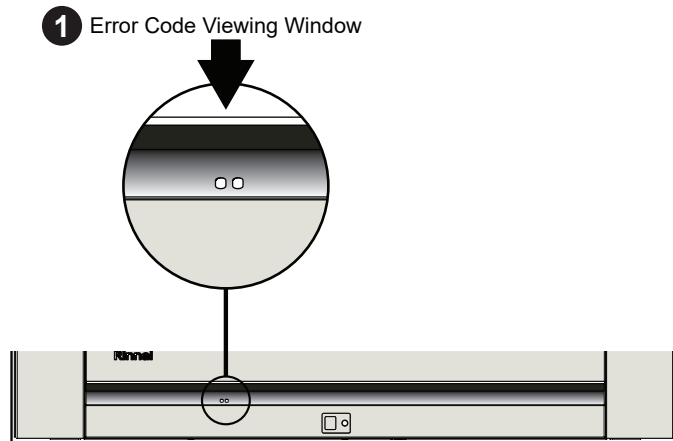

Code	Probable Cause	Suggested Solution
00	Mains power failure	Reset the heater, press the Standby / ON button on the control panel, remote control, or app twice, to turn the fire back on.
11	Ignition failure	Check that the gas supply is turned on. Switch heater to STANDBY and then ON again. If error persists, a service call will be required.
12	Incomplete combustion	As above.
14	Inlet Blockage /Overheat	Clean inlet, if the error persists, a service call will be required
15	Room overheat	Lower room temperature to below 40 °C.
31	Room temperature sensor faulty	Service call.
32	Overheat temp. 1 sensor faulty	Service call.
33	Overheat temp. 2 sensor faulty	Service call.
53	Spark sensor faulty	Service call.
61	Combustion fan motor faulty	Service call.
71	Solenoids faulty	Service call.
72	Flame detection circuit fault	Service call.
73	Communication error	Service call.
90	Communication error between main PCB and Wi-Fi module	Reset Wi-Fi module. Refer to app.
91	Communication error between Smart device and Wi-Fi module	Check your Wi-Fi and Rinnai Wi-Fi module are within range. Check network settings.
92	Cloud function not available	This is due to another device having control on the home network, or the Wi-Fi module has gone offline.



The appliance is fitted with an overheat safety shut-off switch. If the appliance shuts off repeatedly, servicing or inspection of the flue may be required. Contact Rinnai for advice.

CLEANING

Your heater needs very little maintenance, but the following information will help you to keep it looking good and working efficiently.



DO NOT attempt to clean the heater while the appliance is hot or operating.

All parts of the heater can be cleaned using a soft, damp cloth.

DO NOT use solvents or abrasives to clean any parts.

DO NOT spray aerosols in the vicinity of the heater whilst in operation.

DO NOT place articles on or against this heater.

DO NOT store flammable materials near this heater.

DO NOT remove any panels or attempt to carry out any service work other than that which is mentioned in the Trouble Shooting Checklist "Trouble Shooting Checklist" on page 15.

NORMAL OPERATIONAL CHARACTERISTICS

During the initial burning in period some fumes and smell may be experienced. This condition may last for a couple of hours, however this is a normal part of the burning-in process. We recommend to ventilate the space for this period.

When using the heater for the first time, or after a long period of non-use, ignition may not occur the first time it is operated due to air in the gas pipes. If ignition does not occur the unit will switch off automatically. Try operating the heater again. If this condition persists however, contact Rinnai for advice.

The heater may make noises after ignition or switching off. This is due to thermal expansion and contraction of the internal components and is normal.

As a safety precaution the heater will not ignite if the Standby / ON button is pressed immediately after the heater has been turned off. It will take approximately 20 seconds for the unit to reset and switch back on again.

TROUBLE SHOOTING

General Operation Characteristics



Before asking for a service call please check the following table as these characteristics are part of the normal operation of the appliance and do not indicate a fault.

Characteristic	➔ Explanation
At ignition:	
Warm air does not start when the burner lights.	➔ The fan is started automatically after a short delay. This is to allow the heat exchanger to warm up, helping to avoid cold draughts. This is normal operation.
Smoke or strange smells are produced on the first start up after installation.	➔ This is caused by manufacturing oil or dust on the heat exchanger. This is to be expected and will cease after a short time.
Sharp clicking noises at ignition, or when the unit thermostat modulates to a lower or higher setting, or shuts down.	➔ This is simply expansion and contraction noise from the heat exchanger. This is a normal operation sound.
During combustion:	
Dull clunking noise when the thermostat operates.	➔ This is the sound of the solenoid gas valves opening and closing to regulate the gas flow. These are normal operation noises.
When the appliance is turned off:	
Convection fan continues to run after turning 'OFF'.	➔ This is to remove residual heat from the heat exchanger and stops once the appliance cools sufficiently.

TROUBLE SHOOTING CHECKLIST

Check the following information to help determine whether a service call is required. However if you are unsure about the way your heater is operating, or if you have any other faults or problems, please refer to your supplier, installer or a Rinnai Customer Care Centre Consultant. See back page for Rinnai contact details.

Probable Cause	Fault Condition								Simplest Possible Remedy	
	Burners fail to ignite	Smell of gas	Fan Not Working	Minor soot deposits	Severe sooting	Glass, Condensation	Glass, Streaky lines	*Remote not working		*Wi-Fi not working
Not plugged in or turned off	●		●					●	●	Plug in power cord and turn power 'ON'.
Mains power failure	●		●							Re-start, once the power has been restored.
(Initial Install) Air in gas pipe	●									Installer to purge air from gas supply.
Air in hose	●									Repeat Ignition procedure.
Ignition failure	●									Repeat Ignition procedure.
Flat battery for remote control *		●						●		Replace remote control battery.
Gas supply turned off	●									Turn gas supply on at the meter or cylinder.
Gas escape					●					Isolate gas supply, call Rinnai.
Blocked / restricted flue system	●				●					Call Rinnai.
Insufficient gas pressure	●				●					Call Rinnai.
Log Misalignment			●							Call Rinnai.
Normal operation				●		●	●			No action is required.
Normal operation			●							Fan not working - fan automatically comes on after 4 minutes i.e. once heat switch is activated.
Normal operation		●								Allow heater to warm up.
Heat switch not activated			●							Allow heater to run on high for 4 minutes.
Possible fan fault			●		●					Call Rinnai.
Controller display blank	●				●					Replace batteries.
Control panel operation	●							●		Refer to page 10 for solution.
Controller not synchronised								●		Refer to page 10 for solution

* Only applicable when remote control is used.

SERVICE

This appliance does not contain user serviceable parts and **MUST ONLY** be serviced and repaired by an authorised person. If the power supply cord or any other component of the heater are damaged, they **MUST BE** replaced by Rinnai or a suitably qualified person.

Rinnai has a Service and Spare Parts network with personnel who are fully trained and equipped to give the best service on your Rinnai appliance.

Rinnai recommends that this appliance be serviced every 2 years. If your appliance requires service, please call our National Help Line (our contact numbers are on the back cover of this manual).



Service calls for general cleaning, maintenance and wear and tear are not necessarily covered under the warranty. Service calls of this nature may be chargeable.

Faults caused by insufficient gas supply, gas quality, installation errors or operation errors are not covered by the Rinnai warranty. Refer to separate Warranty Manual for details.

ABNORMAL FLAME PATTERN

Each Rinnai Gas Fire has a distinct flame pattern. The flame should look the same every time you operate your heater, after an initial warm up period of approximately 15 minutes.

Abnormal flame performance and/or pattern can indicate a problem with your heater, such as blocked gas injectors, incorrectly installed / inadequate flue system or the Ceramic logs / stones and/or burner media may have shifted from when the heater was first installed.

There are some warning signs that could indicate a problem. If any of the signs below occur, please contact Rinnai.

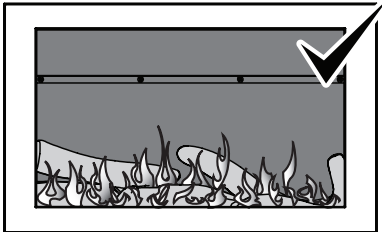

NORMAL FLAME PATTERN

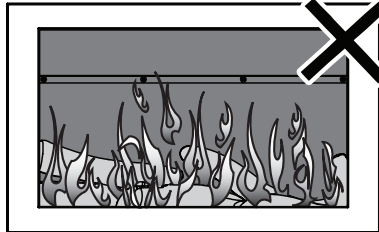

ABNORMAL FLAME PATTERN

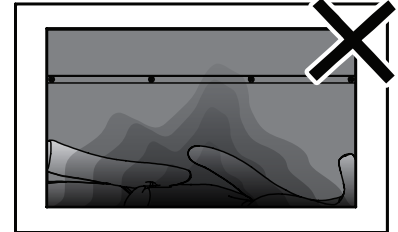

SOOT BUILD UP

Key signs of abnormal flame performance:

- Appliance turns 'OFF' soon after start up and does not relight.
- Flame appears overly orange-yellow.
- Flame appears either very short or very long.
- Flame only burns part way across the burner.
- Severe soot building up on the inside of the glass or on logs.
- Continuous unusual smell from the appliance.
- Continued difficulty or delay in establishing a flame.



Be advised that appliances incorporating a live fuel effect, designed to operate with luminous flames, may exhibit slight carbon deposition. This is normal operation.

CR2450 BUTTON BATTERIES



KEEP BATTERIES OUT OF REACH OF CHILDREN

- Swallowing button batteries may lead to serious injury in as little as 2 hours or death, due to chemical burns and potential perforation of the oesophagus.
- If you suspect your child has swallowed or inserted a button battery immediately call the 24hr Poisons Information Centre on 13 11 26 for fast, expert advice.
- Regularly examine the remote controller and always make sure the battery compartment is completely secured.
- Any used button batteries **MUST BE** disposed of immediately and safely.



The remote control uses 2x CR2450 3V lithium batteries. When the battery change indicator  is displayed, Rinnai recommends batteries be replaced immediately. Full functionality of the heater is dependent on the use of the remote control.

INSTALLATION RECORD



This appliance **MUST** be installed, maintained and removed **ONLY** by an Authorised Person.
For continued safety of this appliance it **MUST** be installed and maintained in accordance with the manufacturers instructions.

The Installation Record is a reference for the end user, help line staff and service technicians. Ensuring that this information is available here will be helpful in the event that a service enquiry is required.

Installation Details

Installation Company Name: _____

Address: _____

Telephone / Mobile Phone: _____ / _____

Email: _____

Certificate of Compliance / Certification No.: _____

Authorised Persons - Licence No.: _____

Installers Name: _____

Installers Signature: _____

Installation Date: _____

Model Number * _____

Serial Number * _____

Installation Address: _____

** This information will need to be copied from the data plate, located on the inside of the appliance.*



Ensure this Operation Manual is kept for future reference.



Ensure installer has instructed you on the correct use of this appliance and completes the Installation Checklist found on page 33 of the Installation Manual.

NOTES



Rinnai Australia Pty Ltd

ABN 74 005 138 769 | AU45204

100 Atlantic Drive, Keysborough, Victoria 3173
P.O. Box 460, Braeside, Victoria 3195
Tel: (03) 9271 6625
Fax: (03) 9271 6622

National Help Line

Tel: 1300 555 545* Fax: 1300 555 655
Monday to Friday, 8.00 am to 5.00 pm EST.

**Cost of a local call may be higher from mobile phones.*

For further information visit www.rinnai.com.au
or email enquiry@rinnai.com.au

Rinnai has a Service and Spare Parts network with personnel who are fully trained and equipped to give the best service on your Rinnai appliance. If your appliance requires service, please call our National Help Line. Rinnai recommends that this appliance be serviced every 2 years.

With our policy of continuous improvement, we reserve the right to change, or discontinue at any time, specifications or designs without notice.