

MODELS

EHPA300VM EHPA300VMH
EHPA340VM EHPA340VMH

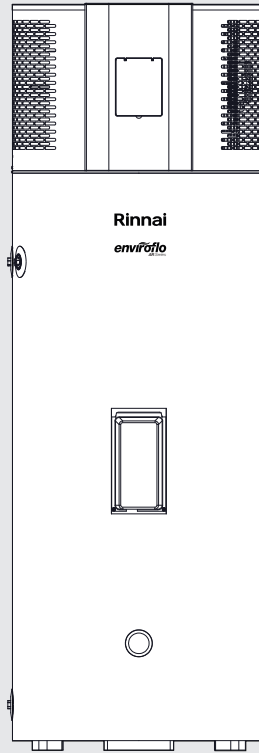

Enviroflo AR Series - Heat Pump Hot Water System
Operation & Installation Manual

Rinnai

This appliance must be installed in accordance with:

- Manufacturer's Installation Instructions
- Current AS/NZS 3500
- Plumbing Code of Australia (PCA)
- Local Regulations and Municipal Building Codes including local OH&S requirements

This system must be installed, commissioned, serviced, maintained and removed **ONLY** by an Authorised Person.

NOT SUITABLE AS A POOL OR SPA HEATER

For continued safety of this appliance it must be installed and maintained in accordance with the manufacturer's instructions.



Certified
Product



WaterMark

Standard: AS3498:2020
Licence Number: WMKA00169
SAI Global



Australian
Standard

Standard: AS/NZS 2712:2007
Licence Number: SMK1849
SAI Global

TABLE OF CONTENTS

Warnings and Important Information	4
Safety and Regulatory Information	4
Transport and Storage of Appliance	5
Scald Hazards	6
Operating Principle	7
System Schematic	7
Safety Devices	8
Excessive Discharge from Safety Devices	8
Hydrogen Gas	9
Anodes	9
Turning Off the Water Heating System	9
Turning On the Water Heating System	9
Draining and Filling	9
Maintenance and Regular Care	9
Save a Service Call	10
Specifications	12
System Specifications	12
Dimensions	13
Clearances	14
Installation	15
Regulations and Occupation Health and Safety (OH&S)	15
Location	15
Water Supply	16
Storage Temperature	16
Hot Water Delivery Temperature	16
Valves and Fittings	16
Transport and Handling	17
Connect the PTR Valve	18
Plumbing Connections	18
Connect Cold / Hot Water Supply	18
Connect Condensate Drain line	19
Electrical Tests	19
Electrical Connections	19
Filling the System	20
Commissioning and Finishing the Installation	20
Wiring Diagram	20
Operation of Controller	21
Controller Layout and Keys	21
LED Icons	22
Controller Functions and Operation	23
Wi-Fi Connection	26
Wi-Fi - Troubleshooting	27
Connection of External Signals	27
Contacts	28

WARNINGS AND IMPORTANT INFORMATION

SAFETY AND REGULATORY INFORMATION



DO NOT operate this system before reading the manufacturers instructions.

This appliance must be installed, commissioned and serviced by an authorised person in accordance with all applicable local rules and regulations.

Access covers of water heating system components will expose 240V wiring and **MUST** only be removed by an authorised person.

This appliance is not intended for use by persons (including children) with reduced physical, sensory or mental capabilities, or lack of experience and knowledge, unless they have been given supervision or instruction concerning use of the appliance by a person responsible for their safety.

For continued safety of this appliance it must be installed, operated and maintained in accordance with the manufacturer's instructions.

Children should be supervised to ensure they **DO NOT** play with the appliance.

The unit is rated at 15 amps (2 core and earth) so the power mains supplying the unit **MUST** have a 20 amp minimum dedicated circuit breaker fitted. If the power supply cable is damaged, it **MUST** be replaced by an authorised person in order to avoid a hazard. Take care not to touch the power connections or plugs with wet hands.

Care should be taken not to touch the pipe work as it may be HOT!

DO NOT place articles on or against this appliance.

DO NOT store chemicals or flammable materials near this appliance.

DO NOT operate with collectors or covers removed from this appliance.

DO NOT activate heat pump unless cylinder is full of water.

NEVER use a flammable spray such as hair spray, paint, etc near this unit as this may cause a fire.



This appliance uses R290 (propane) refrigerant, which is a flammable gas class 3 according to AS 5149 and **MUST** be handled by a refrigeration mechanic with appropriate Australian refrigerant handling licence. Refer to AS/NZS 60335.2.40 for flammable refrigerant handling requirements.

WARNING Risk of fire / flammable material. If the refrigerant is leaked, together with an external ignition source, there is a possibility of ignition.



MANDATORY INSPECTION PRIOR TO INSTALLATION

Immediately report any damage or discrepancies to the Supplier of the appliance. This appliance was inspected and tested at the time of manufacture and packaging, and released for transportation without known damage. Upon receipt, inspect the exterior for evidence of rough handling in shipment. Ensure that the appliance is labelled correctly for the gas and electrical supply, and/or other services it is intended to be connected to.

For safety and warranty purposes, appliances that may be damaged or incorrect **MUST NOT** be installed or operated under any circumstances. Installation of damaged or incorrect appliances may contravene local government regulations. Rinnai disclaims any liability or responsibility whatsoever in relation to the installation or operation of damaged or incorrect appliances.

NOTICE TO VICTORIAN CONSUMERS

This appliance must be installed by a person licensed with the Victorian Building Authority.

Only a licensed person will have insurance protecting their workmanship.

So make sure you use a licensed person to install this appliance and ask for your Compliance Certificate.

For further information contact the Victorian Building Authority on 1300 815 127

TRANSPORT AND STORAGE OF APPLIANCE



The refrigerant used in the heat pump (R290 Propane) is a flammable gas.

The appliance(s) shall be stored and transported in an area without ignition sources (for example: open flames, an operating gas appliance or an operating electric heater)

DO NOT pierce or burn the appliance.

Be aware that refrigerants may not contain an odour.

Compliance with AS/NZS 5149 **MUST** be observed while storing the appliance.



National and state regulations exist for storage, handling and transport of hazardous goods including flammable gasses. The maximum number of pieces of equipment or the configuration of the equipment, permitted to be transported or stored together will be determined by the applicable regulations.



**IMPORTANT
DO NOT TILT
MORE THAN 45°
FROM VERTICAL**

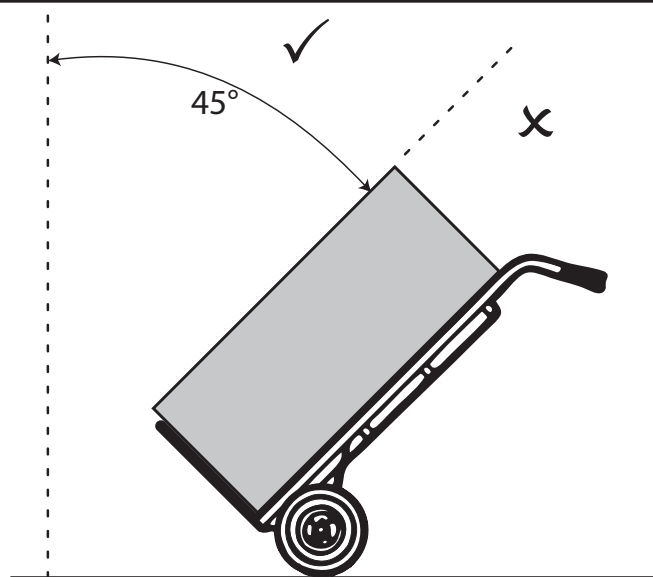

The Rinnai Electric Heat Pump must be transported at an angle no greater than 45° from vertical. As the compressor unit is located at the top of the electric heat pump, should the heat pump be tilted at a greater angle than 45° from vertical, the lubrication oil within the compressor can run down into the mufflers. This will leave the compressor motor without sufficient lubrication and lead to premature failure of the compressor unit.

As a general good practice it is better to keep the compressor upright as much as possible to avoid any risks. Returning the Rinnai Electric Heat Pump to a vertical position will allow the oil to properly flow back into the compressor motor.

Tilting the system beyond 45° from vertical will also place undue strain on compressor motor mounts and associated piping.



Do not use means to accelerate the defrosting process or to clean, other than those recommended by the manufacturer.

The appliance shall be stored in a room without continuously operating ignition sources. For example, open flames, an operating gas appliance or an operating electric heater.

Do not pierce or burn.

Be aware that refrigerants may not contain an odour.

SCALD HAZARDS



**DANGER BEWARE OF
SCALDING HAZARDS**

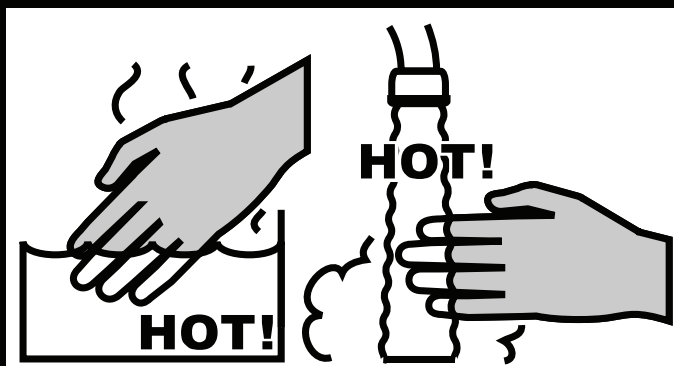

HOT WATER CAN CAUSE SCALDS.

CHILDREN, DISABLED, ELDERLY AND THE INFIRM ARE AT THE HIGHEST RISK OF BEING SCALDED.

FEEL WATER TEMPERATURE BEFORE BATHING OR SHOWERING.

SCALDS FROM HOT WATER TAPS CAN RESULT IN SEVERE INJURIES TO YOUNG CHILDREN.

SCALDS OCCUR WHEN CHILDREN ARE EXPOSED DIRECTLY TO HOT WATER WHEN THEY ARE PLACED INTO A BATH WHICH IS TOO HOT.

ALWAYS.....

Test the temperature of the water with your elbow before placing your child in the bath, also carefully feel water before bathing or showering yourself.

Supervise children whenever they are in the bathroom.

Make sure that the hot water tap is turned off tightly.

CONSIDER.....

Installing child proof tap covers or child resistant taps (both approaches will prevent a small hand being able to turn on the tap).

Installing tempering valves or thermostatic mixing valves which reduce the hot water temperature delivered to the taps. Your local plumbing authority may already require that these be fitted. Contact your installer or local plumbing authority if in doubt.

NEVER....

Leave a toddler in the care of another child. They may not understand the need to have the water temperature set at a safe level.

OPERATING PRINCIPLE

The operation of an electric heat pump is very similar to a refrigerator, but in reverse. A heat pump operates by transferring heat from the ambient outside air into the water. Electricity is just used to operate the system, but not to directly heat the water. Because of this energy consumption is significantly reduced as compared to an electric element hot water system. The warmer the climate in which the heat pump is installed, the more efficient the heat pump system will be at heating water.

The heat pump unit includes highly efficient micro-channel heat exchanger wrapped around the inner cylinder for thermal conductivity. A temperature sensor in the tank is used to control the heat pump operation to achieve suitable tank temperature.

During the occasional times when the ambient weather conditions are not suitable for the heat pump to operate, the electric element will provide heating to ensure a supply of hot water.

SYSTEM SCHEMATIC

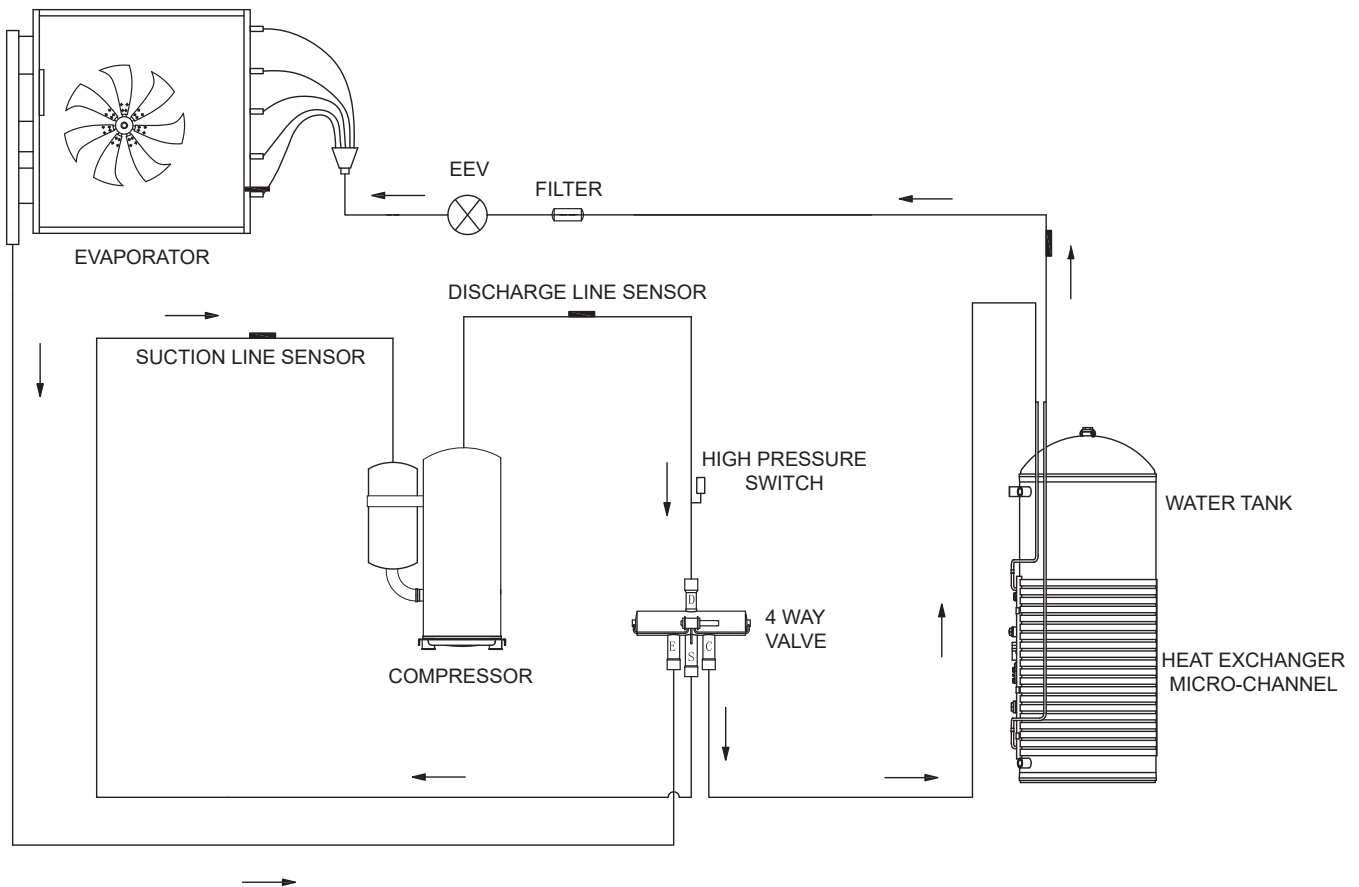

SAFETY DEVICES

The water heating system is supplied with various safety devices including temperature sensors, overheat sensors and switches and a Pressure & Temperature Relief (PTR) valve. These devices must not be tampered with or removed. The water heating system must not be operated unless each of these devices is fitted and is in working order.



DO NOT tamper with or remove safety devices.

DO NOT operate the water heater unless all safety devices are fitted and in working order.

DO NOT block or seal the PTR Valve and drain pipe.

Pressure & Temperature Relief (PTR) Valve

This valve is located near the top of the water heater and is essential for safe operation. It is normal for the valve to release a small quantity of water through the drain line during heating.

However, continuous leakage of water from the valve and its drain line may indicate a problem with the water heater.

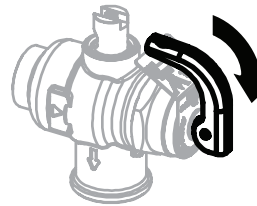

Lift lever until water flows from drain line (Lower lever gently!)



NEVER block the outlet of the PTR valve or its drain line for any reason. The easing gear **MUST** be operated at least every 6 months to remove lime deposits and verify that it is not blocked. Failure to do this may result in the water heater failing.

If the valve does not discharge water when the easing gear lever is opened, or does not seal again when the easing gear is closed, attendance by an authorised person **MUST** be arranged without delay. The PTR valve is not serviceable.

EXCESSIVE DISCHARGE FROM SAFETY DEVICES

Pressure & Temperature Relief (PTR) Valve

It is normal and desirable that this valve allows a small quantity of water to be discharged during the heating cycle. If it discharges more than a bucket of water during a 24 hour period or discharges continuously there may be another problem.

If the valve dribbles continuously, try easing the valve gear for a few seconds as described above. This may dislodge any foreign matter and alleviate the problem.

If the valve discharges at high flows, especially at night, it may be as a result of the water pressure exceeding the design pressure of the water heater. Ask your installer to fit a Pressure Limiting Valve (PLV).



NEVER replace the PTR valve with one which has a higher pressure rating than is specified for your water heater.

Expansion Control Valve (ECV) - if required

It is normal that this valve allows a small quantity of water to be discharged during the heating cycle. If it discharges more than a bucket of water during a 24 hour period or discharges continuously there may be another problem.

If the valve leaks continuously, try easing the valve gear for a few seconds. This may dislodge any foreign matter which may be causing the problem. If this does not fix the issue, contact Rinnai.

Operate the easing gear regularly to remove any lime deposits and to verify that it is not blocked.

HYDROGEN GAS

If the hot water unit is not used for two weeks or more, a quantity of hydrogen gas, which is highly flammable, may accumulate in the water heater. To dissipate this safely, it is recommended that a non electrically operated hot tap be turned on for two minutes at a sink, basin, or bath, but not a dishwasher or other appliance. During this procedure there must be no smoking, open flame or any electrical appliance operating nearby. If hydrogen is discharged through the tap, it will probably make a sound like air escaping.

ANODES

The water heater is fitted with sacrificial anodes to extend its life. They will slowly dissipate whilst protecting the cylinder. The life of the water heater may be extended by arranging for an authorised person to inspect the anodes and replace them as required. It is recommended that the anodes be inspected at least every 5 years. The factory fitted Rinnai anodes are Magnesium based. These anodes are suited to conditions where the total dissolved solids (TDS) content in the water supply does not exceed 600 mg/L, (which is the case in most areas). In areas where the total dissolved solids (TDS) content in the water supply exceeds 600 mg/L Rinnai aluminium based anodes are required.

TURNING OFF THE WATER HEATING SYSTEM

If you plan to be away for only a few nights, we suggest you leave the water heating system switched on. If it is necessary to switch off the water heater, do so as outlined below:



DO NOT turn power off to the heat pump unit if snow or frost conditions are expected as components in the system may be damaged by freezing. If power needs to be turned off or power failure occurs and freezing conditions are expected, the water needs to be drained from the heat pump unit. Follow the procedure described below in the section 'Draining and Filling'.

TURNING ON THE WATER HEATING SYSTEM

Switch on the electric supply to the heat pump unit. Water heating will now occur as required. It may take a number of hours before hot water is available.

DRAINING AND FILLING

Draining or filling of the complete system normally only occurs during installation or servicing and must be carried out by an authorised person.

Draining water from the heat pump unit is necessary if the power will be shut off to the unit and snow or frost conditions are expected. **Arrange for an authorised person to carry out this task.**

To drain the heat pump:

1. Turn off power to the heat pump.
2. Close the cold water mains supply stop cock.
3. Open a hot tap to relieve pressure.
4. Disconnect the hot outlet near the top of the storage cylinder.
5. Disconnect the cold inlet near the bottom of the storage cylinder.
6. The system will now drain completely.

MAINTENANCE AND REGULAR CARE

Operate the easing gear of the PTR and the ECV if fitted as described in the section 'Safety Devices' on page 8.

The overflow tray (supplied by installer) and drain underneath the storage cylinder (if fitted) should be periodically checked to ensure there are no blockages.



DO NOT drill, screw or fix any ancillary items to the outer case of the tank. This product is fitted with a high efficiency heat exchanger attached to the inner cylinder, anything penetrating the outer skin of the tank may damage the heat exchanger. Rinnai's warranty will not cover any resultant faults.

SAVE A SERVICE CALL

Rinnai's servicing network personnel are fully trained and equipped to give the best service on your Rinnai appliance. If your appliance needs service, ring one of the service contact numbers on the back of this booklet.

The pressure and temperature relief valve and expansion control valve (if fitted) must be replaced by an authorised person at intervals not exceeding 5 years or more frequently in areas where the water is classified as scaling water.

If the power supply cord to the heat pump unit is damaged, they must be replaced by an authorised person in order to avoid a hazard.

Use the following guide to avoid the need for an unnecessary service call.

INSUFFICIENT OR NO HOT WATER	
Heat Pump Unit Not Powered	Check to ensure the electric isolating switch at the switchboard (usually marked "Hot water" or "Water heater" is turned on. (note that the compressor will not start up for 2 minutes after power is turned on).
Excessive hot water consumption	Often end users are surprised at the amount of hot water used, especially when showering. If the amount of hot water used during the day exceeds the storage capacity of the cylinder, it is likely there will be insufficient hot water.
Pressure & Temperature Relief (PTR) Valve continually discharging water	<p>It is normal and desirable that this valve allows a small quantity of water to be discharged during the heating cycle. If it discharges more than a bucket of water during a 24 hour period or discharges continuously there may be another problem.</p> <p>If the valve dribbles continuously, try easing the valve gear for a few seconds as described in the section 'Excessive Discharge from Safety Devices' on page 8. This may dislodge any foreign matter and alleviate the problem.</p> <p>If the valve discharges at high flows, especially at night, it may be as a result of the water pressure exceeding the design pressure of the water heater. Ask your installer to fit a Pressure Limiting Valve (PLV).</p>
Expansion Control Valve (ECV) continually discharging water	<p>It is normal and desirable that this valve allows a small quantity of water to be discharged during the heating cycle. If it discharges more than a bucket of water during a 24 hour period or discharges continuously there may be another problem.</p> <p>If the valve leaks continuously, try easing the valve gear for a few seconds as described in the section 'Excessive Discharge from Safety Devices' on page 8. This may dislodge any foreign matter and alleviate the problem. If this does not alleviate the problem contact Rinnai.</p>
Ambient conditions too hot	To protect the components of the heat pump unit it may not operate when the ambient temperature is higher than 45°C. The heating element will operate if water heating is required, but may take longer to heat the water.
Ambient conditions too cold	To protect the components of the heat pump unit it may not operate when the ambient temperature is less than -7°C. The heating element will operate if water heating is required.
NO WATER FROM THE TAP	
Restriction in the hot tap or failure of the cold water supply to the water heater	Check for water flow at the other taps and that the cold water isolation valve is fully open.

HIGH ELECTRICITY BILLS		
Excessive hot water consumption	See entry under the heading 'Insufficient or no hot water'	
High Electricity Tariffs	The electricity tariff will determine the running costs of the system. It is important the end user is aware of the applicable tariffs. Contact your electricity supplier to confirm what these tariffs are.	
Higher Element Usage	In extremely cold conditions the element may be operating more than normal.	
WATER FLOW FLUCTUATIONS		
One or more hot taps opened at the same time	<p>More than one or two hot taps in use at the same time may cause a decrease in the hot water flow from the taps.</p> <p>Is there more than one or two hot taps open, or are appliances such as a dishwasher or washing machine, in use at the same time?</p> <p>Ensure only one or two hot taps are on at one time.</p>	
WATER HAMMER		
Hot and cold water plumbing in the premises	Have a plumber check clipping of hot and cold water pipe work and install a pressure limiting valve and water hammer arrestor as required.	
HEAT PUMP ICES UP		
Defrosting function	The heat pump has a built in hot bypass defrosting function which may operate and remove any ice.	
HEAT PUMP ERROR INDICATOR*		
Error code	Error Description	Possible Causes
E01	Ambient temperature sensor fault	Sensor fault/Connection is loose
E02	Upper tank temperature sensor fault	Sensor fault/Connection is loose
E03	Discharge temperature sensor fault	Sensor fault/Connection is loose
E04	Evaporator temperature sensor fault	Sensor fault/Connection is loose
E05	Suction temperature sensor fault	Sensor fault/Connection is loose
E06	Lower tank temperature sensor fault	Sensor fault/Connection is loose
E07	High pressure switch protection	Pressure switch is open circuit /Connection is loose/EEV fault/Refrigeration system is blocked
E08	Discharge temperature too high	Lack of refrigerant/system leak
E09	Low supply voltage	Mains power voltage is too low
E10	High supply voltage	Mains power voltage is too high
*If an error code is displayed on the control unit please contact Rinnai Customer Care Immediately.		

SPECIFICATIONS

SYSTEM SPECIFICATIONS

Model		EHPA300VM EHPA300VMH	EHPA340VM EHPA340VMH
Net Weight / Filled Weight		128 kg / 428 kg	138 kg / 478 kg
Tank Volume		300 L	340 L
Ambient Temperature Limits (for heat pump operation - element will operate beyond these limits)		-7°C to 45°C	
Ingress Protection		IP24	
Storage Cylinder - Hot Outlet and Cold inlet Connections		ISO 7.1 ¾" RP	
Storage Cylinder - PTR Valve Connection		ISO 7.1 ½" RP	
Pressure & Temperature Relief (PTR) Valve (Supplied) Setting / Rating		1000 kPa / 10kW	
ECV Fitted	Fit PLV if mains pressure exceeds	680 kPa	
	Recommended PLV pressure rating	500 kPa	
ECV Not Fitted	Fit PLV if mains pressure exceeds	800 kPa	
	Recommended PLV pressure rating	500 kPa	
Rated Input Electric Element (Factory Wired)		2.4 kW	
Maximum Input Refrigeration Module (Factory Wired)		1.2 kW	
Total Maximum Input		3.4 kW	
Maximum Energy Output (Use to size PTR)		7.5 kW	
Power Supply		220V-240V AC/50 Hz.	
Switchboard Power Circuit		20 Amp Dedicated Safety Switch Circuit Breaker	
Maximum Current		14.5 Amps (15 Amps rating power supply)	
Sound Pressure Level*		45 dB(A)	
Refrigerant Type / Mass		R290 / 380 g	
Refrigerant Circuit Maximum Pressure		3000 kPa	
Coefficient Of Performance (COP)	32.6°C Ambient 21.1°C cold water inlet	8.4	
Heat Output	32.6°C Ambient 21.1°C cold water inlet	4.4 kW	

*Sound Pressure Level @1.5m. Sound Levels on installations can be higher due to noise reflections from nearby surfaces and structures.

DIMENSIONS

Model	EHPA300VM	EHPA340VM
	EHPA300VMH	EHPA340VMH
Cylinder height	1925 mm	2095 mm
Hot water outlet / PTR height	1259 mm	1429 mm
Cold water inlet height	116 mm	
Cylinder diameter	652 mm	

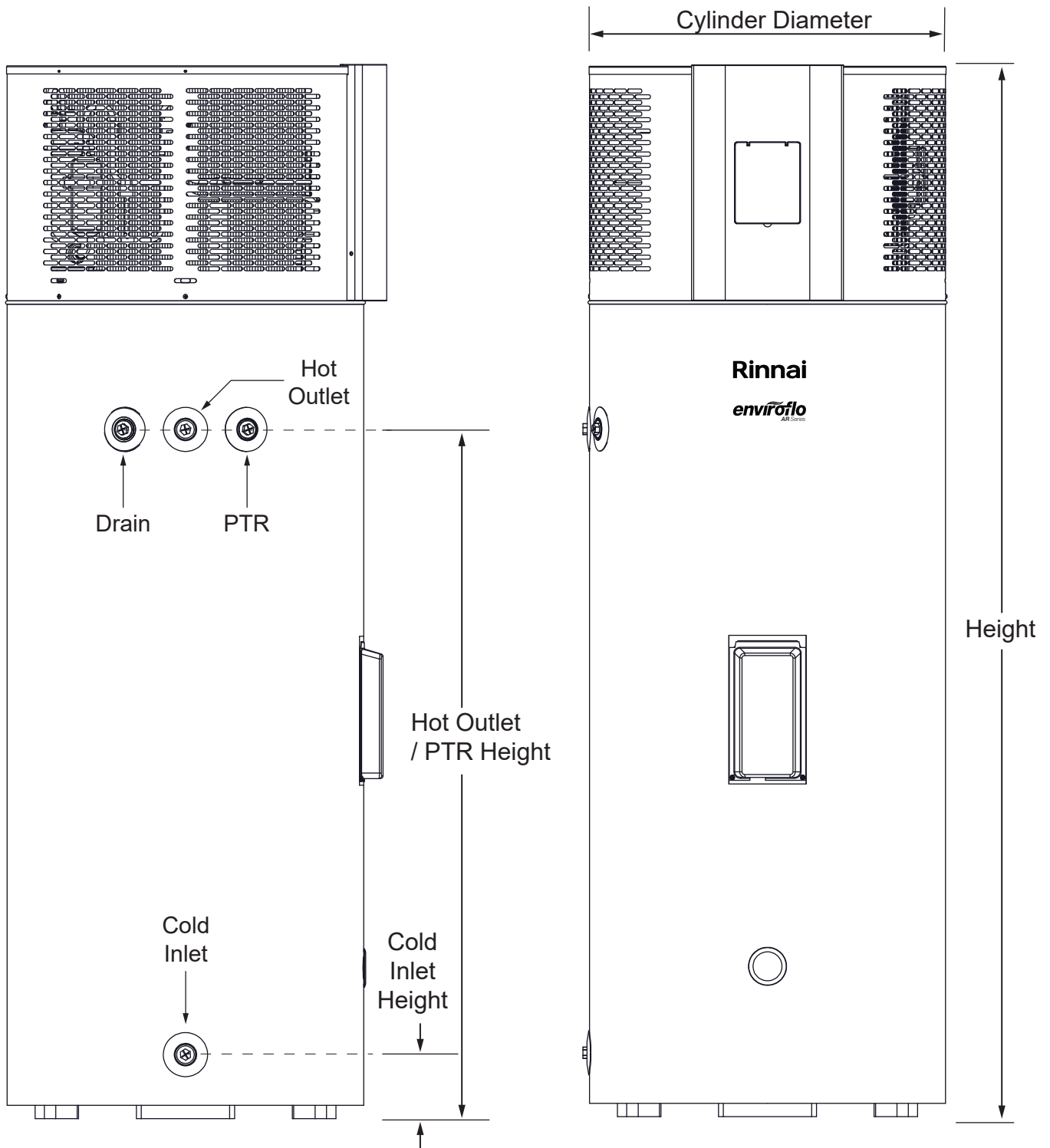

SPECIFICATIONS

CLEARANCES

Always allow 500 mm minimum clearance on the fan discharge side and 150 mm minimum clearance on the fan suction side to allow for sufficient air flow through the fan.

Allow 300 mm minimum vertical clearance for service access and 300mm to the front for control operation.

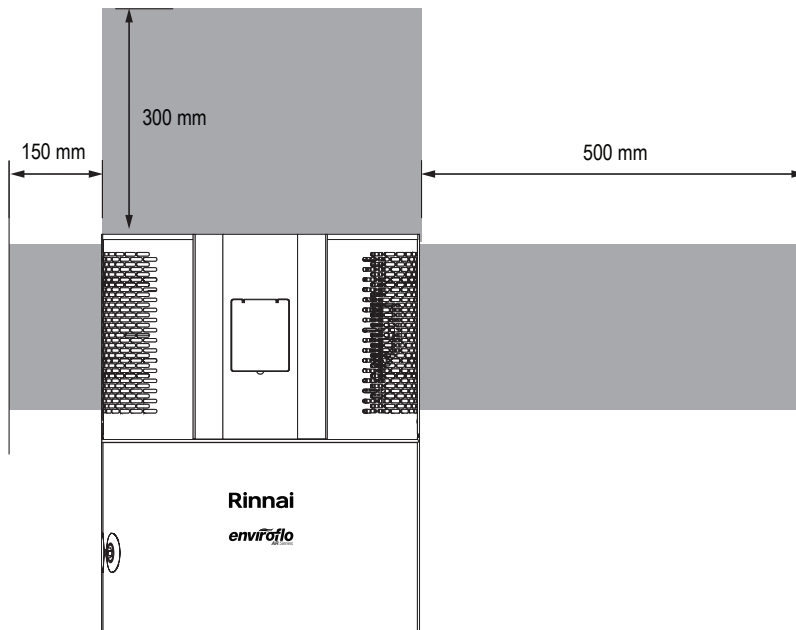
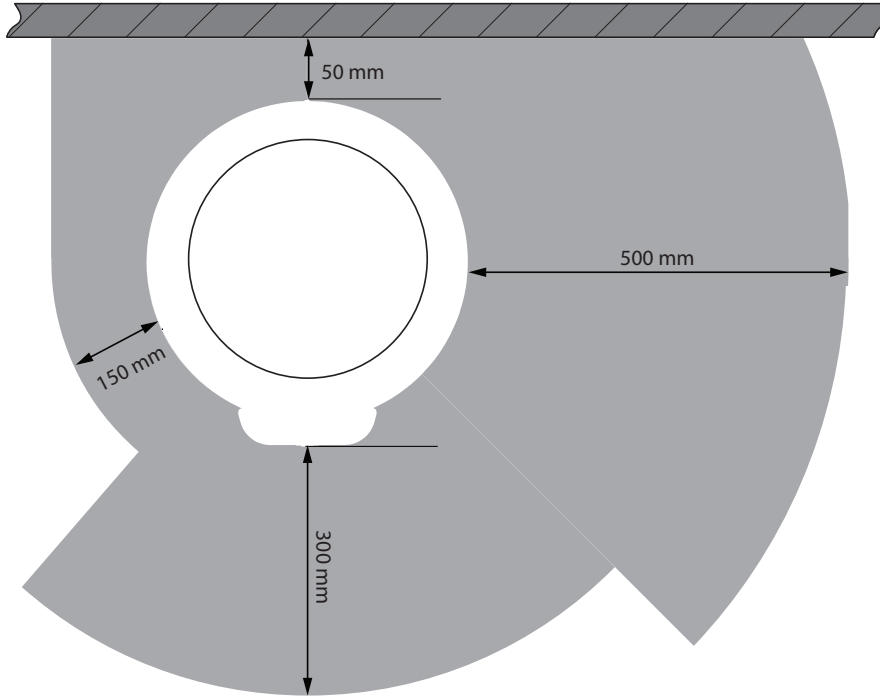

INSTALLATION

REGULATIONS AND OCCUPATION HEALTH AND SAFETY (OH&S)



Installation and commissioning **MUST** be performed by authorised persons.

The heat pump **MUST** be installed in accordance with these instructions and all regulatory requirements which exist in your area including those in relation to manual lifting.

Applicable publications and regulations may include:

- AS/NZS 3500 National Plumbing and Drainage
- AS/NZS 3000 Wiring Rules
- Building Codes of Australia (BCA)
- Local Occupational Health and Safety (OH&S) regulations

This appliance is not suitable for use as a domestic spa pool or swimming pool heater.

Electric Heat pumps are heavy and bulky items. Australian States and Territories have a Principal Occupational Health and Safety (OH&S) Act which contains requirements relating to the handling of large, bulky or awkward items. Persons installing heat pump systems **MUST** be aware of their responsibilities and be adequately trained and qualified, in accordance with local OH&S requirements.

LOCATION

The electric heat pump can be installed externally or internally.

The electric heat pump should be placed as close as practicable to the most frequently used hot water outlet point or points to minimise the delay time for hot water delivery. This will usually be the kitchen tap. For installations where the distance between the heat pump and the outlets is considerable, a flow and return system can be used which minimise the waiting time for hot water delivery. We recommend not to install the unit close to where operational sound levels may cause occupant disturbances, such as bedrooms.

It is recommended that all components are installed at ground or floor level with consideration for easy service, repair or replacement access.. The heat pump **MUST** be installed in a vertically upright position. All components **MUST** be accessible without the use of a ladder or scaffold. The unit **MUST NOT** be installed in roof spaces.



Ensure the location complies with the requirements of AS/NZS 60335.2.40 & AS/NZS 5149.

The air inlet and outlet of the heat pump module **MUST** be away from areas with strong wind and **MUST** be provided with sufficient clearances as per those shown in the section 'Clearances' on page 14.

The heat pump **MUST** be connected to an independent AC 240 V, 50 Hz power supply, 20 Amp Dedicated Safety Switch Circuit Breaker and 20 Amp Weatherproof Isolating Switch

Ensure the pressure and temperature pressure relief (PTR) valve and any access covers have sufficient clearances and are accessible for service and removal. The information on the rating plates **MUST** also be readable.

The heat pump **MUST** be installed free-standing on a level and stable base. The cylinder should be mounted on a concrete base at least 50mm thick or on well-seasoned, evenly spread hardwood slats with a thickness of at least 25mm. Where property damage can occur as a result of water leakage, the storage cylinder **MUST** be installed with a safe tray (overflow tray) and drain in accordance with AS 3500.4. Ensure the storage cylinder **DOES NOT** stand on wet surfaces.

Internal Installation

For internal installations the area **MUST** meet the following requirements:

- Minimum room volume of 55m³ per unit.
- Good Ventilation (i.e minimum 280 L/s per unit)
- Away from any ignition sources or corrosive environments.

If the heat pump is installed internally careful consideration should be taken in regards to positioning and limiting the effect of unit noise and reverberation during operation, which may cause noise disturbances otherwise.

Condensation

As this heat pump is highly efficient, the surrounding air temperature could be cooled by up to 4°C and condensate formed, the condensate outlet will need to be plumbed to a suitable drain.

Drainage

Where property damage can occur as a result of water leakage, the water heater **MUST** be installed with a safe tray (overflow tray) and drain. Construction, installation and draining of the safe tray **MUST** comply with local regulatory requirements and AS/NZS 3500.4 also requires the use of a safe tray for particular situations.

WATER SUPPLY

This appliance is intended to be permanently connected to the water mains and not to be connected by a hose set.

The maximum water pressure is listed on page 12. An approved pressure limiting valve may be required if the maximum rated water supply pressure is exceeded.

Water chemistry and impurity limits are detailed in the separate warranty document. Most metropolitan water supplies fall within these requirements. If you are unsure about water quality and suitability, contact your water authority.

A water filter **MUST** be fitted on the inlet to the tank to prevent sludge or foreign matter entering the system.

In a scaling water supply, calcium carbonate and possibly other compounds are deposited out of the water onto any hot metallic surface and form a scale. Scaling water may cause scale deposits to form onto the metallic surfaces of the PTR valve and may prevent it from operating properly. To prevent this, an expansion control valve (ECV) **MUST** be fitted on the cold water line after the non-return valve in areas of scaling water. ECVs' **MUST** be fitted in South Australia and Western Australia to comply with local regulations.

STORAGE TEMPERATURE

If the tank water temperature is set below 60°C, the system will automatically override this setting once a week to activate the disinfection cycle, heating the water to 60°C to meet regulatory requirements. This setting can not be altered.

HOT WATER DELIVERY TEMPERATURE

This appliance may deliver water at high temperature. Refer to the Plumbing Code of Australia (PCA), local requirements and installation instructions to determine if additional delivery temperature control is required.

The PCA, local regulations and the requirements of AS/NZS 3500.4 **MUST** be considered regarding the temperature limitations of hot water supplied to areas used primarily for personal hygiene.

The temperature of water to certain areas is limited to different temperatures according to purpose, for e.g. early childhood centres, primary and secondary schools and nursing homes or similar facilities for young, aged, sick or people with disabilities and for all other buildings. To comply with these requirements, a temperature limiting device, such as a thermostatic mixing or tempering valve, will be required on hot water systems.

VALVES AND FITTINGS



A 10 kW capacity, combined Pressure and Temperature Relief (PTR) valve is supplied with the Heat Pump hot water system. This valve is fitted at the top of the storage cylinder. The PTR valve is a safety device and it is mandatory that it is fitted by the installer in all installations..

The following valves & fittings are to be supplied by the installer:

- A cold water expansion control valve (ECV). An ECV **MUST** be fitted in Western Australia and South Australia to the cold water supply to the storage cylinder to comply with local regulations. An ECV is recommended in all other geographical areas where the water supply has a tendency to cause scaling. This will reduce hot water discharge from the pressure and temperature relief (PTR) valve which minimises wear on this valve.
- A stop cock, non return valve and line strainer. Combination valves incorporating two or more of these functions (such as 'Trio' valves) are suitable. These are fitted to the cold water supply to the storage cylinder by the installer.
- Cold water supply and hot water discharge pipework to and from the storage cylinder. This pipework **MUST** be insulated as specified in AS/NZS 3500.4
- An approved pressure limiting valve (supplied with some systems) is required if the maximum rated water supply pressure on page 12 is exceeded.
- Tempering valve(s) or thermostatic mixing valve

TRANSPORT AND HANDLING



When moving the unit, it **MUST** be close to vertical at all times.

When using a trolley to move the unit, ensure it is not tilted more than 45° from the vertical.

Non compliance will void warranty and severely affect product performance and operation

The Rinnai Electric Heat Pump **MUST** be transported at an angle no greater than 45° from vertical.

As the compressor unit is located at the top of the electric heat pump, should the heat pump be tilted at a greater angle than 45° from vertical, the lubrication oil within the compressor can run down into the mufflers.

This will leave the compressor motor without sufficient lubrication and lead to premature failure of the compressor unit.

As a general good practice it is better to keep the compressor upright as much as possible. Returning the Rinnai Electric Heat Pump to a vertical position will allow the oil to properly flow back into the compressor motor.

Tilting the heat pump beyond 45° from vertical will also place undue strain on compressor motor mounts and associated piping.

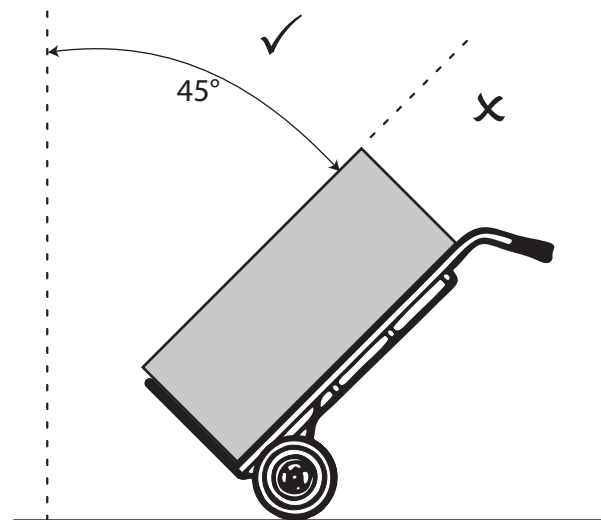

Never tilt unit more than 45° from vertical

POSITIONING THE HEAT PUMP

Arrive at site and conduct a safety audit. Safety audits can also be known as Work Method Statements (WMS) or Job Site Analysis (JSA).

Park your vehicle as close as allowable to your installation. Unload all materials in a safe manner.

Position all materials in a convenient position near the work area.

Where the requirements for internal installation can't be met, the heat pump **MUST** be installed outdoors.

The location **MUST** consider noise impact on living areas. Avoid positioning near bedrooms or neighbours' bedrooms. Although the running noise level is very low it can be expected that the heat pump will run during the night.

Adequate access **MUST** be available to the relief valve and anodes.

Safely position the new unit on a level surface in accordance with all plumbing and building regulations.

A properly drained overflow tray **MUST** be used where property damage could occur from water spillage. (See AS/NZS 3500.4.2 for further details.)

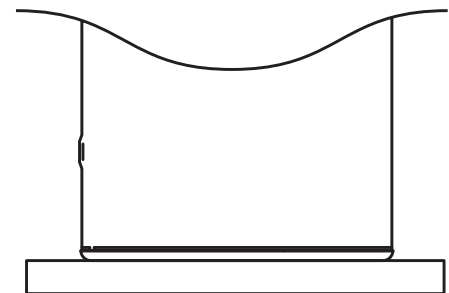

Install a plinth under the heat pump where it is subjected to wet conditions



DO NOT drain on to grass or garden beds.

DO NOT commence a job where the risks cannot be controlled.

Allow 200m³ of free space surrounding the unit. This provides clear ambient airflow assisting the product's performance. Ensure the clearance requirements specified in the section 'Dimensions' on page 13. are complied with. The area **MUST** also be clear of debris such as leaves and tree branches.

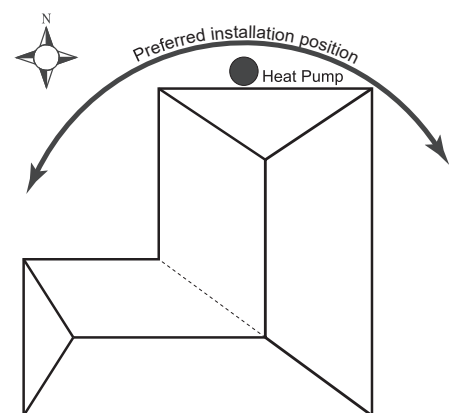

Optimum installation location is on the warmest side of house.

CONNECT THE PTR VALVE

Connect the PTR valve to the uppermost fitting of the storage cylinder. See the diagram in the section 'Dimensions' on page 13.

The PTR pressure rating **MUST** be suited for the cylinder and adequate for the thermal loading applied to the storage cylinder, as specified in the table on page 12. The supplied PTR valve input rating is 10 kW. The PTR valve rating **MUST EXCEED** the total input from the heat pump (see the table on page 12). As this is less than 10 kW, the supplied PTR valve is of sufficient capacity.

Use PTFE (Teflon) thread tape on the valve, never use hemp or other sealing materials. Ensure the tape does not protrude past the end of the thread, which could result in it hanging over the end of the thread and blocking the water passage through the valve.

Connect the supplied PTR valve into the top socket marked "Relief Valve" Leave the valve outlet pointing down. Tighten the valve using the spanner flats - never use the valve. Discharge according to plumbing regulations. PTR Valves for the unit are rated at 1000 kpa.

The drain line from this valve **MUST** run in a continuously downward direction with the discharge end left permanently open to atmosphere.

PLUMBING CONNECTIONS

Refer to the diagram on page 13 for detailed information on position of plumbing.

An approved isolating valve, non return valve, line strainer, and union **MUST** be fitted between the supply main and the RP ¾ socket in the water heater. All fittings **MUST** be approved by the relevant installation Authority.

An ECV **MUST** be fitted in Western Australia and South Australia to the cold water supply to the storage cylinder to comply with local regulations.

An ECV is recommended in all other geographical areas where the water supply has a tendency to cause scaling.

This will reduce hot water discharge from the Pressure and Temperature Relief (PTR) valve which minimises wear on this valve.

This water heater is designed for direct connection to water supply pressures of no greater than those specified on page 12. Where the mains pressure can exceed or fluctuate beyond this, a pressure limiting (PLV) device (complying with AS1357) **MUST** be fitted.

CONNECT COLD / HOT WATER SUPPLY

Connect cold water supply, Pressure Limiting Valve (PLV) and or Expansion Control Valve (ECV).

Connect cold water supply to the storage tank (refer to Diagram BELOW).

A stop cock, non return valve and line strainer **MUST** be fitted.

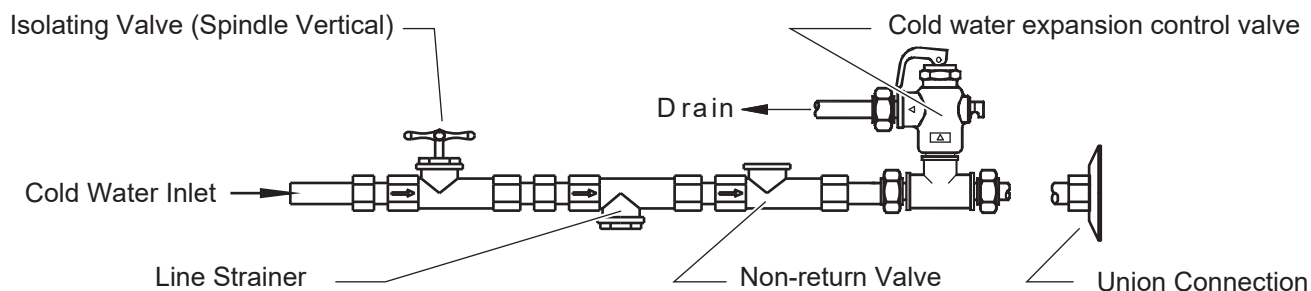

Connect the pipe work supplying hot water to the premises to the hot water outlet on the tank.

A temperature limiting device may be required as detailed in the section the section 'Hot Water Delivery Temperature' on page 16

It is recommended that all hot water lines are insulated with high temperature, UV resistant 13mm closed cell insulation.

CONNECT CONDENSATE DRAIN LINE

A condensate drain line **MUST** be fitted to carry discharge clear of the water heater.

The condensate drain line should not be connected to the PTR drain line but can exit to the same point.

The diagram shows the condensate drain location on the heat pump. Use the supplied PVC pipe (inner diameter 19mm, UV resistant) and clamp to connect to the condensate outlet.

Independent 15mm copper pipes **MUST** be fitted to the PTR and ECV drain outlets.

Each pipe **MUST** be open to atmosphere and run with a continual downward grade in a frost free environment to a visible discharge point.

Drain lines **MUST NOT** exceed 9 meters in length. Valves or other restrictions **MUST NOT** be placed in the relief valve drain outlet line.

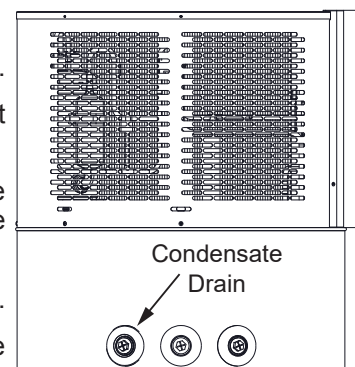

ELECTRICAL TESTS

DO NOT turn on the power supply to the appliance until it has been filled with water and a satisfactory insulation (Megger) test has been performed.

Conducting Insulation (Megger) Tests

When conducting an insulation test using a Megger on this appliance, observe the following:

 **WARNING** This appliance contains electronic components, when performing insulation tests (500 Volts) this **MUST ONLY** be conducted the across active terminal to earth and then across the neutral terminal to earth.

Tests between the active to neutral terminals **MUST NOT** be performed as this **WILL** damage the electronic components.

Insulation test results of between **100 kΩ** and **660 kΩ** are normal for this appliance.

In accordance with AS/NZS 3000 an insulation test with a result less than **1 MΩ** is permitted where the appliance is approved to a Standard applicable to that class of appliance.

This appliance is categorised and certified as a 'stationary Class 1 motor operated appliance' and therefore satisfies the requirements of AS/NZS 60335.2.40 for leakage current and electric strength. As such, this appliance complies with the insulation resistance requirements of AS/NZS 3000.

ELECTRICAL CONNECTIONS

 **WARNING** The power supply to the heat pump module **MUST NOT** be activated until the system is filled with water.

The premises wiring to the heater **MUST** be capable of withstanding the appliance load. Refer to specification table for load details.

All electrical connections and wiring **MUST** be installed, maintained and removed by authorised persons in accordance with AS/NZS 3000, and all other relevant local regulations and municipal building codes including OH&S requirements.

 **IMPORTANT** The Heat Pump is **NOT** equipped with a power cord and plug and **MUST** be hard-wired to an isolating switch with dedicated circuit as per the wiring rules. The supply terminals **MUST** be connected to an independent AC 240V 50Hz power supply with a 20 Amp safety switch. The isolator **MUST** effectively isolate all active supply conductors from the circuit. A method for disconnection **MUST** be incorporated into the fixed wiring in accordance with the relevant wiring rules and regulations.

In Australia, a Residual Current Circuit Breaker (RCD) must be installed to the power supply for this appliance.

 **IMPORTANT** Disconnect all power prior to installation and commissioning.

This appliance is designed for single phase 240 Volts, AC mains electrical operation.

WIRING DIAGRAM

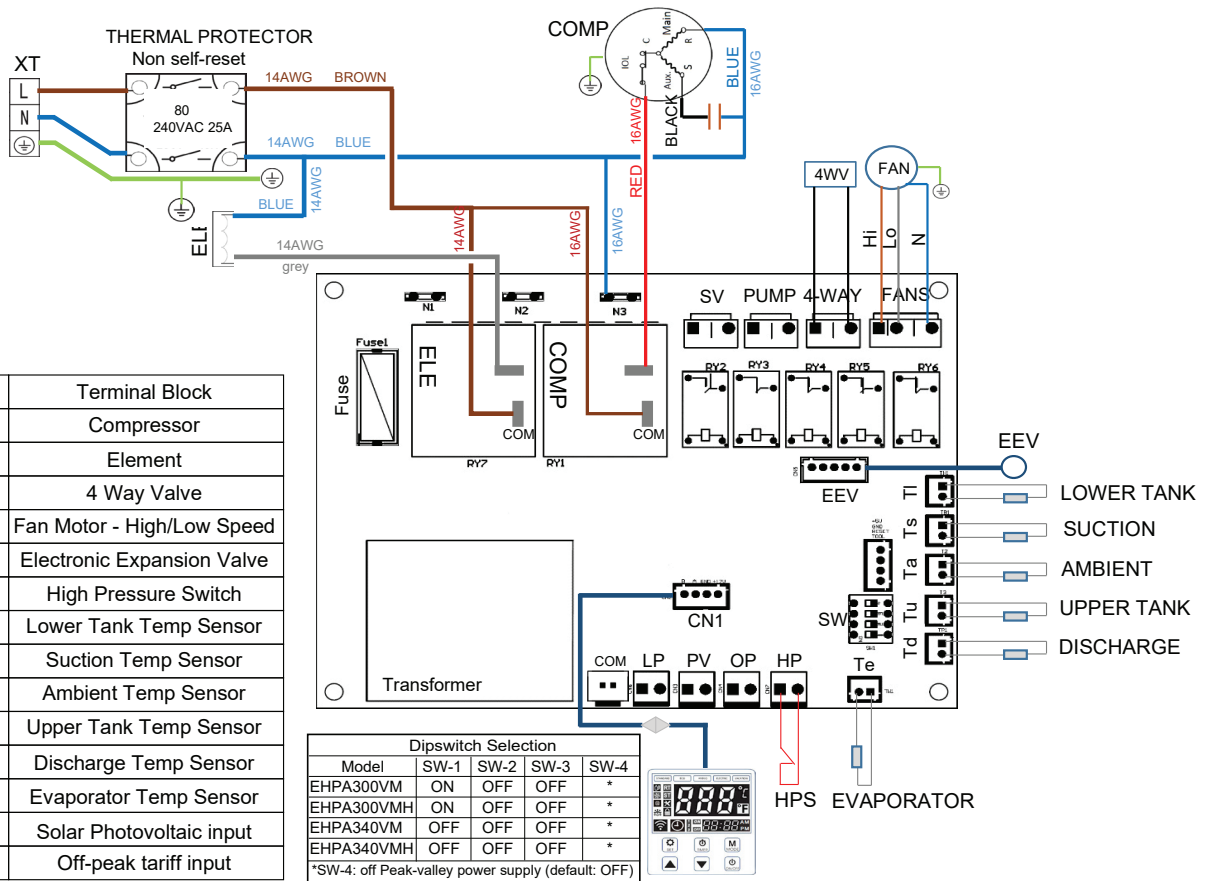

FILLING THE SYSTEM

Open hot water tap at sink.

Open the stop cock in the cold water main supply line. Allow the system to fill and the air to bleed through the tap.

Turn off the hot tap at the sink when water flows freely without any air bubbles or air bursts. If leaks are detected, repair any leaks and repeat the filling process to remove any air.

If no leaks are detected water heating can commence.

COMMISSIONING AND FINISHING THE INSTALLATION



Please confirm the followings before commissioning:

- Piping and electrical wiring are all correct and Earthing wire is installed properly.
- Pipe insulation is completed
- Tank is filled
- Supply Voltage complies with rated voltage
- Air intake and discharge are not obstructed

Turn on the heat pump unit and wait a few seconds for the system to start. Change operation mode or water temperature setting if required (it is recommended to retain default setting).

After testing is completed demonstrate the functions and operation of heat pump water heater components to the householder. Explain the need to drain the heat pump if freezing conditions are likely and when power may be shut off for an extended time.

Also explain the importance of performing maintenance in accordance with this manual. Leave the manual with the householder.



DO NOT drill, screw or fix any ancillary items to the outer case of the tank. This product is fitted with a high efficiency heat exchanger attached to the outer cylinder, anything penetrating the outer skin of the tank may damage the heat exchanger. Rinnai's warranty will not cover any resultant faults.

OPERATION OF CONTROLLER

When the heat pump turns on, the control system initiates and will check the unit's operating parameters. The controller will check on all sensors and pressure switches. If conditions are suitable (i.e all reading within the reasonable range) and there is enough energy available in the surrounding air, the fan and compressor will turn on. If not enough energy is detected in ambient air then the controller calls for the booster heating element to run.

There will be a delay from the time the heat pump is switched on before the fan and compressor begin operating.

The unit is self regulating so there are no internal adjustments to be made during commissioning. When the unit is operated for the first time, it runs through an initial heat up cycle, allow time for the initial heat up cycle. Depending on the ambient conditions this can take several hours.

If for any reason the unit does not start, the water is cold and the controller unit is not displaying any LED lights, an electrician should test that power is available to the heat pump.

CONTROLLER LAYOUT AND KEYS

All major functions are controlled by the Control Panel situated on the front of the unit.

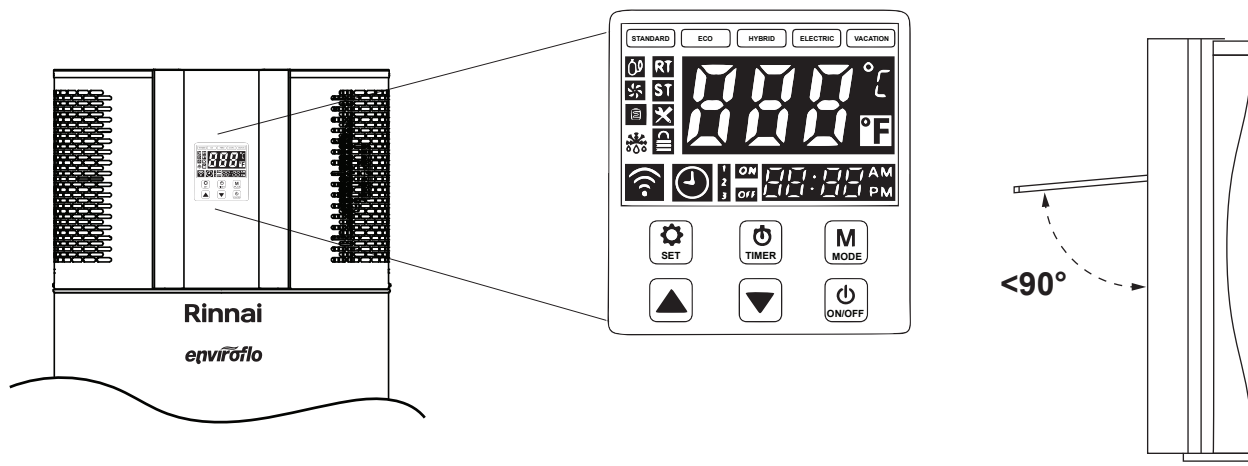

Weatherproof Cover

Carefully flip up the weatherproof cover and ensure not open it more than 90°. To close, gently press it until the locking tabs at the bottom lock in place (See drawing above).

Key Primary Functions

The following table describes the primary function of each key on the controller





Key	Icon	Primary Functions
SET		<ol style="list-style-type: none"> 1. Enter value setting or saves changes 2. Operation data query (press and hold the key for 3s)
TIMER		<ol style="list-style-type: none"> 1. Sets the clock 2. Sets the timer (press and hold the key for 3s)
MODE		<ol style="list-style-type: none"> 1. Switches operating modes
ON/OFF		<ol style="list-style-type: none"> 1. Unlocks the screen 2. Turns unit on or off (press and hold for 3s) 3. Used as a return button in parameter setting
UP		<ol style="list-style-type: none"> 1. Increases set temperature 2. Navigates parameter setting
DOWN		<ol style="list-style-type: none"> 1. Decreases set temperature 2. Navigates parameter setting

















Ensure the controller unit is not displaying an Error Code once unit has been switched on. If it is refer to the section 'Save a Service Call' on page 10

Key Combinations

The keys can also be used in specific combinations to provide additional functions:

Keys	Function
	Press and hold for 3 seconds to enter WiFi connection mode
	Press and hold for 3 seconds to activate manual defrost function
	Press and hold for 3 seconds to activate manual disinfection function
	Press and hold for 3 seconds to restore factory setting

LED ICONS

Symbol	Function	Meaning when lit	Meaning when flashing
	Standard heating mode	Mode active	-
	Economy heating mode	Mode active	-
	Hybrid heating mode	Mode active	-
	Electric heating mode	Mode active	-
	Vacation mode	Mode active	-
	Real water temperature	Display current water temperature	-
	Set water temperature	Display set water temperature	-
	Maintenance reminder	Maintenance required	-
	Screen lock	Screen locked	Still locked (2Hz flashing)
	Compressor	Compressor active	-
	Fan	Fan active	-
	Element	Element active	Disinfection operation (1Hz flashing)
	Defrosting	Defrosting active	-
	WiFi	WiFi connected	Searching for network (1Hz flashing)
	Timer	Timer active (number 1,2,3 will be lit accordingly)	-



CONTROLLER FUNCTIONS AND OPERATION

1. Turn ON/OFF the heat pump:

In normal display status, press the “” key for 3 seconds to turn on or turn off the unit. The unit will enter the mode and setting it was in prior to shutdown (or factory default setting if it is the first time powering on).

When turning off the unit, the unit will not function and the display will lock and show OFF.

2. Lock and unlock:

If there is no key operation for 90 seconds, the screen will lock and go blank automatically. Press any key to light the screen. The “” icon will be lit indicating it is locked. Press the “” key for 3 seconds to unlock.

3. Operation Mode selection

Press the “” key to cycle modes in the sequence: STANDARD → ECO → HYBRID → ELECTRIC → VACATION.



The system default mode is ECO. When the unit is switched on for the first time, the system will operate under ECO mode. Subsequently, the unit will start in the mode setting it was in prior to shutdown.

No.	Mode	Product Model	Set Point - Factory Default (°C)	Restart Differential (°C)	Set Point Range (°C)
1	STANDARD	All models	60.5 *	5	15~61
2	ECO (Factory default)	EHPA300VM	60.5 *	12	15~61
		EHPA300VMH			
		EHPA340VM	60	11	
		EHPA340VMH			
3	HYBRID	All models	65	10	15~70
4	ELECTRIC	All models	70	8	15~70
5	VACATION	All models	20	12	15~61

* Shows as 61°C in user interface.

STANDARD Mode:

The user should select this mode for use in commercial applications. In this mode, the water heating is done by the compression system except when the ambient temperature is below -7°C or above 45°C.

ECO Mode:

This is the default mode as the heat pumps leave the factory. In this mode, the water heating is done by the compression system except when the ambient temperature is below -7°C or above 45°C.

HYBRID Mode:

In this mode, when the water temperature is below 40°C, water heating is carried out by the compression system and the heating element simultaneously. When the water temperature is between 40°C and 60°C, the water heating is carried out by the compression system. When the water is greater than 61°C, water heating is carried out by the resistive heating element.



ELECTRIC Mode:

In this mode, water heating is done by the resistive heating element.







VACATION Mode:

In this mode, water heating is done by the compression system. This mode is to be used when there is no need for hot water for an extended period of water.

4. Water temperature setting

Unlock the controller in the main interface then press the “” or “” key to increase or decrease the water temperature setting value. The value changes by 1°C. It is recommend not to alter factory the default temperature setting.

5. Clock setting

In the main interface, press the “” key to enter the clock setting interface. The hour part of the clock will flash, press the “” or “” key to cycle the hour value. When the hour is set, press the “” key to confirm. The minute part of the clock will now flash. Press the “” or “” key to cycle the minute value. After the minute is set, press the “” key to confirm the real-time clock setting and return to the main interface.









In the real-time clock setting interface, if there is no key operation for 10 seconds, the current clock setting value will be confirmed and will return to the main interface.

If the unit is connected to Internet (WiFi), the real-time clock will automatically update to local time.

6. Operation Timer Setting

It is possible to set three different timers. Press and hold the “” key for 3 seconds in the main interface to enter timer setting.

The timer No.1 symbol will flash, press the “” or “” key to turn on or turn off timer No.1 and the display will show Off or On accordingly.

When the timer No.1 is turned on, the symbol  will light. Press the “” key to set the start time, the symbol ‘1’ will light and the hour section of the timer flashes, press the “” or “” key to cycle the hour value. When the hour is set, press the “” key to confirm. The minute section of the timer will now flash. Press the “” or “” key to cycle the minute value. After the minute is set, press the “” key to confirm and begin setting the end time. The hour section of end time flashes, follow the same procedures to set the end time.

After the timer No. 1 is set, switch to the next timer setting (No.2 and No.3), the setting method is the same as above. Press the “” key to exit and return to the main interface.

If the start time of a certain working period is greater than the end time, the end time is considered to be of the next day.

When the start time and end time of a setting are the same, it will not be set.

In the timer setting interface, if there is no key operation for 30 seconds, the current timer setting value will be confirmed and will return to the main interface.

7. WiFi connection Setting



In normal display status, press and hold the ‘Up’ key’ and ‘Down’ key’ () for 3 seconds to enter the Wi-Fi network connection mode. The Wi-Fi icon will flash. When connected successfully, the Wi-Fi symbol will remain lit.



Please refer to “Wi-Fi Connection” on page 26 for Wi-Fi Function setup instructions.

8. Disinfection:



Manual Disinfection:

In normal display status, press the “” and “” keys and hold for 3 seconds to activate manual disinfection function. All tank water will be heated up to 60°C. The symbol ‘element’ will flash during disinfection.





Auto Disinfection:

If the setting temp < 60°C, the heat pump will start disinfection automatically over a 7-day period. The disinfection can operate outside of the timer. All tank water will be heated up to 60°C, then it will exit disinfection.

9. Manual Defrosting

When the heat pump (compressor) is running, press the “” and “” keys and hold for more than 3 seconds to activate manual defrosting function. The symbol ‘defrost’ will light when defrosting is operating.

10. Operation Data Query (for use by qualified installation and maintenance personnel)

In normal display status, press and hold the  key for 3 seconds to enter the unit operation data query. Press the  or  key to query each code and value. Press the  key to exit and return to the main interface. See the following table for data query.

Code	Description	Unit	Note
d01	Ambient temperature	°C	Measured value
d02	Upper tank temperature	°C	Measured value
d03	Discharge temperature	°C	Measured value
d04	Evaporator temperature	°C	Measured value
d05	Suction temperature	°C	Measured value
d06	Lower tank temperature	°C	Measured value
d07	High pressure switch status	-	0N=Closed; OFF=Open
d08	Mains voltage	V	Measured value (reference only)
d09	EEV opening	step	Real value
d10	Fan speed	-	Lo=Low speed; Hi=High speed; OFF
d11	Compressor	-	ON=Running; OFF=Stop
d12	4-way valve status	-	ON (defrosting); OFF
d13	Defrosting status	-	ON (defrosting); OFF
d14	Electric element	-	ON (activated); OFF
d15	PV signal status	-	ON; OFF
d16	Off-peak tariff status	-	ON; OFF
d17	Disinfection status	-	ON; OFF
d18	Mains voltage protection	-	ON(enabled); OFF(disabled)
d19	One-shot boost	-	ON(enabled); OFF(disabled)
d20	Compressor working time	h	*100 as reading
d21	Unit power on time	h	*100 as reading
d22	Software version	-	
d23	Product model	-	
d31	Last fault code	-	
d32	Second last error code	-	
d33	Third last error code	-	
d34	Forth last error code	-	
d35	Fifth last error code	-	
d36	Sixth last error code	-	
d37	Seventh last error code	-	
d38	Eighth last error code	-	
d39	Nineth last error code	-	
d40	Tenth last error code	-	

WI-FI CONNECTION

Please follow below steps to set up and operate Wi-Fi functions.

1. Prepare a Wi-Fi wireless router that can access the Internet, The Wi-Fi frequency band must be 2.4 Ghz and should be placed within 10 meters of the water heater to ensure that a strong Wi-Fi signal is available.
2. Turn on Wi-Fi and Bluetooth on your device. After the connection is successful, you can turn off Bluetooth and operation will not be affected.
3. Scan the QR code below or search in the app market to download and install the 'Smart Life' App.
 - iOS users – please download from App Store
 - Android users – please download from Google Play



4. After completing the installation, open the App, register an account and log in according to the App prompt.
5. To connect the controller to your network Press and hold the UP and DOWN keys (▲+▼) together for 3s, to enter into manual network connection mode. When the controller is available for connecting to Wi-Fi network, the symbol “📶” will flash. When connected successfully, the symbol “📶” will remain continuously lit up.

NOTE You will need to repeat step 5 if the icon stops flashing during the connection

6. Connect to the SmartLife App as follows:

<p>i) Search for Device</p>	<p>ii) Add Found Device</p>	<p>iii) Connect to Wi-Fi</p>	<p>iv) Wait to Connect</p>	<p>v) Complete</p>

7. Control the Heat Pump with the App

The main controls for the App are laid out as follows on the App.

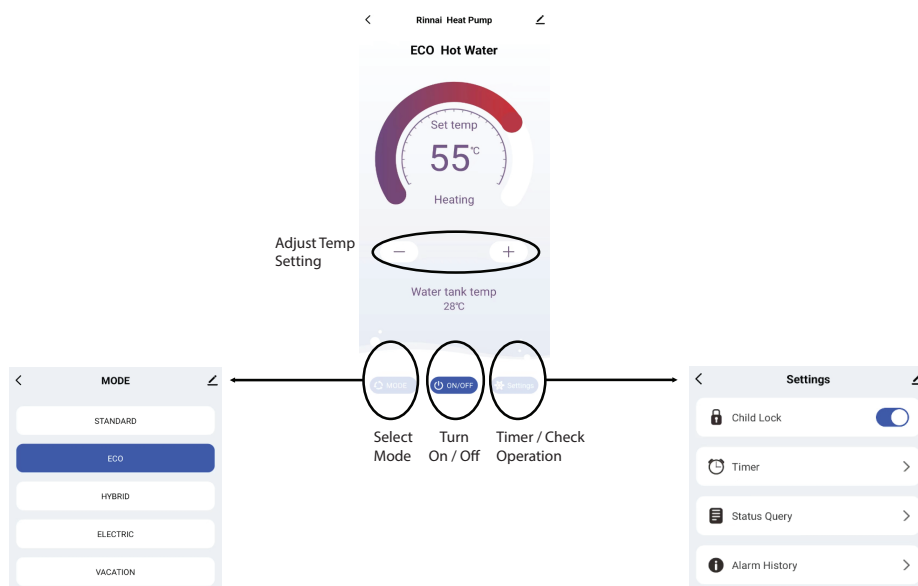

WI-FI - TROUBLESHOOTING

Issue	Potential Cause
Configuration cannot be completed	Check that you are only connected to the 2.4Gz WIFI frequency. You may be required to temporarily turn off you 5Gz WIFI frequency at the modem during the configuration process.
	Check your WIFI signal strength at the hot water unit. You will require a minimum of 3 bars WIFI signal to be connected..
	Check you have the correct app downloaded. .
	Check you have the minimum requirements as stated at the beginning of this manual.

CONNECTION OF EXTERNAL SIGNALS



This type of connection MUST only be carried out by a qualified electrician.

1. Solar photovoltaic system

A solar photovoltaic signal can be integrated via the built-in dry contact input 'PV' on the main controller. When the heat pump receives 'closed' signal from the solar PV system and the signal lasts for 30 seconds, the restart differential will temporarily change to 2°C for at least 10 minutes to take advantage of electricity generated on site to produce more hot water.

2. Off-peak electricity

Off-peak tariff signal can be integrated via the built-in dry contact input 'OP' on the main controller. This feature shall be configured through dipswitch SW-4 on the main controller. When SW-4 is switched to ON, the heat pump only operates at receiving 'closed' signal. This feature accesses the heat pump to utilize off-peak electricity. Please note that if timer is activated, the off-peak setting will be overridden by the timer.



The unit can not be connected to OFF PEAK meters.

In this case the system will be OFF (No power when connected to this meter) causing, the disinfection timer to stop counting down.

If the water temperature drops below the required level for an extended period, there is a risk of legionella developing in the hot water system.

Rinnai Australia Pty Ltd

ABN 74 005 138 769 | AU45204

100 Atlantic Drive, Keysborough, Victoria 3173
P.O. Box 460, Braeside, Victoria 3195
Tel: (03) 9271 6625

National Help Line

Tel: 1300 555 545*

Monday to Friday, 8.00 am to 5.00 pm EST.

After Hours Hot Water Service Line

Tel: 1800 000 340*

**Cost of a local call may be higher from a mobile phone.
(National calls from public phones in Australia are free.)*

For further information visit **www.rinnai.com.au**
or email **enquiry@rinnai.com.au**

Rinnai has a Service and Spare Parts network with personnel who are fully trained and equipped to give the best service on your Rinnai appliance. If your appliance requires service, please call our National Help Line. Rinnai recommends that this appliance be serviced every 3 years.

With our policy of continuous improvement, we reserve the right to change, or discontinue at any time, specifications or designs without notice.