

MODELS

System	Indoor	Outdoor
HSNRP26B	HINRP26MB	HONRP26B
HSNRP35B	HINRP35MB	HONRP35B
HSNRP50B	HINRP50MB	HONRP50B
HSNRP60B	HINRP60MB	HONRP60B
HSNRP70B	HINRP70MB	HONRP70B
HSNRP80B	HINRP80MB	HONRP80B
Ref Only	HINRP20MB	Matching Multi System Only

REFRIGERANT
R32

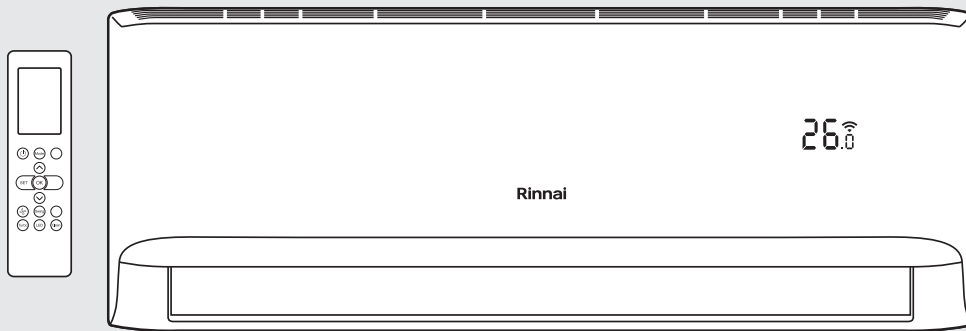

PB Series Split Type Wall Mounted Air Conditioner Operation Manual

Rinnai

This appliance must be installed in accordance with:

- Manufacturer's Installation Instructions
- Current AS/NZS 3000, AS/NZS 5141, AS/NZS 5149
- Local Regulations and Municipal Building Codes including local OH&S requirements

This appliance must be installed, maintained and removed only by an Authorised Person.

For continued safety of this appliance it must be installed and maintained in accordance with the manufacturer's instructions.



TABLE OF CONTENTS

Warnings and Important Information	4
Air Conditioner Basics	7
Indoor Unit Specifications and Features	7
Operating Temperature	8
Basic Operation	8
General Maintenance	11
Care & Maintenance	11
Cleaning Your Indoor Unit	11
Cleaning Your Air Filter	11
Troubleshooting	13
Common Issues	13
Installation Record - Installer Details	16
Installation Record - System Details	16
Customer Care Program	16
Service Maintenance Schedule - Non Ducted Air Conditioning Systems	17
Warranty	18
Contacts	24



Scan QR to register your warranty

WARNINGS AND IMPORTANT INFORMATION



READ ALL INSTRUCTIONS BEFORE USING THE APPLIANCE.

Always comply with the following precautions to avoid dangerous situations and to ensure optimum performance.

Failure to carefully read and follow all instructions in this manual can result in equipment malfunction, property damage, personal injury and/or death.

DANGER: Indicates an imminently hazardous situation which, if not avoided, will result in personal injury or death.

WARNINGS: Indicates a potentially hazardous situation which, if not avoided, could result in personal injury or death.

CAUTIONS: Indicates a potentially hazardous situation which, if not avoided, could result in minor or moderate injury or damage to the appliance. It may also be used to alert against unsafe practices.



REGULATORY

This appliance shall be installed in accordance with:

Manufacturer's Installation Instructions.

Current AS/NZS 3000, AS/NZS 5141, AS/NZS 5149.

Local Regulations and Municipal Building Codes including local OH&S requirements.

This appliance must be installed, maintained and removed **ONLY** by an Authorised Person.

For continued safety of this appliance it must be installed and maintained in accordance with the manufacturers instructions.

This appliance uses R32 refrigerant.

This appliance is heavy, use 2 people or mechanical lifting device. Improper lifting may result in serious injury.

Take care when opening or unpacking this appliance. Failure to do so may result in serious injury or product failure.

DO NOT modify the electrical wiring of this appliance. If the control power wiring is damaged or deteriorated then it must be replaced by an authorised person. Failure to do so may result in electric shock, fire, serious injury or product failure.

DO NOT install the air conditioner on an unstable or non level surface or where there may be a danger of it falling. It may result in death, serious injury, or product failure.

DO NOT install the outdoor unit where noise may cause nuisance.

DO NOT install the outdoor unit where it will be exposed to sea wind (salt spray) as this will reduce durability.



MANDATORY INSPECTION PRIOR TO INSTALLATION

Immediately report any damage or discrepancies to the Supplier of the appliance. This appliance was inspected and tested at the time of manufacture and packaging, and released for transportation without known damage. Upon receipt, inspect the exterior for evidence of rough handling in shipment. Ensure that the appliance is labelled correctly for the gas and electrical supply, and/or other services it is intended to be connected to.

For safety and warranty purposes, appliances that may be damaged or incorrect **MUST NOT** be installed or operated under any circumstances. Installation of damaged or incorrect appliances may contravene local government regulations. Rinnai disclaims any liability or responsibility whatsoever in relation to the installation or operation of damaged or incorrect appliances.



REFRIGERANT

This appliance uses R32 (difluoromethane) refrigerant, which is a flammable gas class 2.2 according to AS 1677 and must be handled by a refrigeration mechanic with appropriate Australian refrigerant handling licence.



WARNING Risk of fire / flammable material. If the refrigerant is leaked, together with an external ignition source, there is a possibility of ignition.



Read the OPERATING INSTRUCTIONS carefully before operation.



Service personnel are required to carefully read the OPERATING INSTRUCTIONS and INSTALLATION MANUAL before operation.



Further information is available in the OPERATING INSTRUCTIONS, INSTALLATION MANUAL, and the like.

Certain levels of refrigerant require minimum room sizes. Please ensure that these minimum room sizes are adhered to for standard installations (up to 10m pipe length). If larger refrigerant charges than standard are used then please consult AS/NZS 60335.2.40 to determine the safe minimum floor area for the installation.

Make sure that the area has been made safe by having suitable ventilation and is free from ignition sources before charging or releasing the charge of R32.

Model	HSNRP26B	HSNRP35B	HSNRP50B	HSNRP60B	HSNRP70B	HSNRP80B
Standard Charge (g)	900	900	1260	1260	1400	1400
Minimum Floor Area (m ²)	4.0	4.0	4.0	4.0	4.0	4.0



OPERATION

DO NOT let the air conditioner run for extended periods when the humidity is very high or when doors or windows are left open. As this may result in an excessive operational loading and lead to product failure.

DO NOT cover or place articles on any part of this appliance.

DO NOT touch, operate or clean the air conditioner with wet hands. It may result in electric shock or product failure.

DO NOT insert hands or other objects through the air inlet or outlet while the appliance is operating. It may result in electric shock or product failure.

DO NOT place a heater or other heating appliances near this appliance, always ensure sufficient ventilation when using this appliance and a heating appliance at the same time. Failure to do so may result in product mis-operation.

Turn main power off before cleaning. Failure to do so may result in fire, electric shock, or product failure.

DO NOT use solvents, abrasives or harsh detergent to clean any part or surface of this appliance or spray water or allow liquids to enter the indoor unit. The enclosure of the appliance and remote control can be cleaned using a soft, damp cloth and a mild detergent.

NEVER touch the metal parts of the air conditioner when you remove the air filter. It may result in electric shock or product failure.

DO NOT leave flammable materials near the appliance. It may result in explosion or fire.

If there is excessive noise, smell or smoke coming from the appliance, turn the appliance off, isolate the power supply and contact a service agent.

DO NOT operate the appliance if it has been submerged into water due to flooding, contact a service agent. Failure to do so may result in electric shock, fire, serious injury, or product failure.

This appliance is not intended for use by persons (including children) with reduced physical, sensory or mental capabilities, or lack of experience and knowledge unless they have been given supervision or instruction concerning use of the appliance by a person responsible for their safety.

Children should be supervised to ensure that they **DO NOT** play with the appliance.

The air conditioning system is designed to achieve consumer comfort. It is **NOT** designed for commercial applications requiring a controlled atmosphere (i.e. computer rooms, food preservation, etc.)

DO NOT block the inlet or outlet of air flow. It may result product in failure.

DO NOT drink the condensate water drained from the appliance. This condensate is not potable and may present a health risk if consumed.

DO NOT expose people, animals or plants directly to the cold or hot discharge of the appliance. It may result in serious injury.

DO NOT mix the batteries for the remote control with other types of batteries or mix new batteries with used batteries. Failure to do so may result in product failure. **STOP** using the remote control if there is a battery fluid leak.

OPERATION RANGE LIMITATIONS

The table below indicates the temperature ranges the air conditioner can be operated within.

MODE	Cool Mode	Heat Mode	Dry Mode
Room Temperature	> 16°C	< 30°C	> 16°C
Outdoor Temperature	0°C ~ 50°C	-15°C ~ 24°C	0°C ~ 50°C

AIR CONDITIONER BASICS

Indoor Unit Specifications and Features

NOTE: Different models have different front panels and display windows. Not all the display codes describing below are available for the air conditioner you purchased. Please check the indoor display window of the unit you purchased.

Illustrations in this manual are for explanatory purposes. The actual shape of your indoor unit may be slightly different. The actual shape shall prevail.

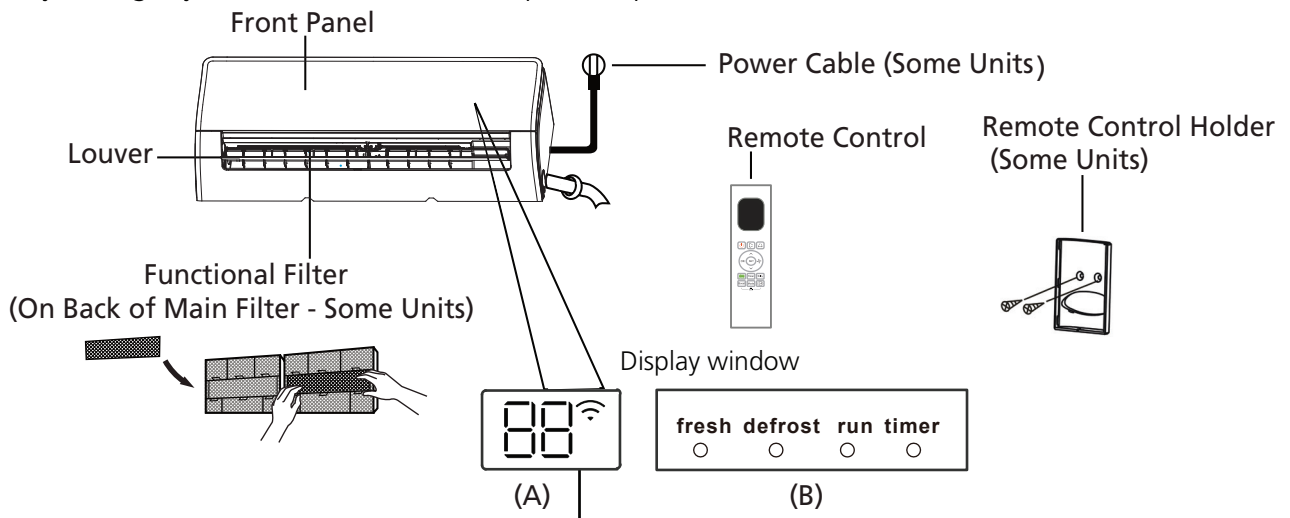

- "fresh " when Fresh feature is activated(some units)
- "defrost" when defrost feature is activated.
- "run " when the unit is on.
- "timer " when TIMER is set.
- "📶 " when Wireless Control feature is activated(some units)
- "88" Displays temperature, operation feature and error codes:
 - "00 " for 3 seconds when:
 - TIMER ON is set (if the unit is OFF, "00" remains on when TIMER ON is set)
 - FRESH, SWING, TURBO, ECO,or SILENCE feature is turned on
 - "0F " for 3 seconds when:
 - TIMER OFF is set
 - FRESH, SWING, TURBO, ECO,or SILENCE feature is turned off
 - "dF " when defrosting
 - "FP " when 8°C heating feature is turned on(some units)
 - "CL " when Active Clean feature is turned on(For Inverter split type)
when unit is self-cleaning(For Fixed-speed type)

Display Code Meanings

BASIC OPERATION

Operating Temperature

When your air conditioner is used outside of the following temperature ranges, certain safety protection features may activate and cause the unit to disable.

Inverter Split Type

	COOL mode	HEAT mode	DRY mode
Room Temperature	17°C - 32°C	0°C - 30°C	10°C - 32°C
Outdoor Temperature	0°C - 50°C	-15°C - 24°C	0°C - 50°C
	-15°C - 50°C (For models with low temp. cooling systems.)		
	0°C - 52°C (For special tropical models)		0°C - 52°C (For special tropical models)

FOR OUTDOOR UNITS WITH AUXILIARY ELECTRIC HEATER

When outside temperature is below 0°C, we strongly recommend keeping the unit plugged in at all times to ensure smooth ongoing performance.

Fixed-speed Type

	COOL mode	HEAT mode	DRY mode
Room Temperature	17°C-32°C	0°C-30°C	10°C-32°C
Outdoor Temperature	18°C-43°C	-7°C-24°C	11°C-43°C
	-7°C-43°C (For models with low-temp cooling systems)		18°C-43°C
	18°C-52°C (For special tropical models)		18°C-52°C (For special tropical models)

NOTE: Room relative humidity less than 80%. If the air conditioner operates in excess of this figure, the surface of the air conditioner may attract condensation. Please sets the vertical air flow louver to its maximum angle (vertically to the floor), and set HIGH fan mode.

To further optimize the performance of your unit, do the following:

- Keep doors and windows closed.
- Limit energy usage by using TIMER ON and TIMER OFF functions.
- Do not block air inlets or outlets.
- Regularly inspect and clean air filters.

A guide on using the infrared remote is not included in this literature package. Not all the functions are available for the air conditioner, please check the indoor display and remote control of the unit you purchased.

Other Features

- Auto-Restart(some units)**
 If the unit loses power, it will automatically restart with the prior settings once power has been restored.
- Anti-mildew (some units)**
 When turning off the unit from COOL, AUTO (COOL), or DRY modes, the air conditioner will continue operate at very low power to dry up condensed water and prevent mildew growth.
- Wireless Control (some units)**
 Wireless control allows you to control your air conditioner using your mobile phone and a wireless connection.
 For the USB device access, replacement, maintenance operations must be carried out by professional staff.
- Louver Angle Memory(some units)**
 When turning on your unit, the louver will automatically resume its former angle.
- Active Clean function(some units)**
 -- The Active Clean Technology washes away dust, mold, and grease that may cause odors when it adheres to the heat exchanger by automatically freezing and then rapidly thawing the frost. A sound will be heard.
 The Active clean operation is used to produce more condensed water to improve the cleaning effect, and the cold air will blow out. After cleaning, the internal wind wheel then keeps operating with hot air to blow-dry the evaporator, thus preventing the growth of mold and keeping the inside clean.
 -- When this function is turned on, the indoor unit display window appears "CL", after 20 to 45 minutes, the unit will turn off automatically and cancel Active Clean function.
- Breeze Away (some units)**
 This feature avoids direct air flow blowing on the body and make you feel indulging in silky coolness.
- Refrigerant Leakage Detection (some units)**
 The indoor unit will automatically display "EL0C" or flash LEDs (model dependent) when it detects refrigerant leakage.
- Sleep Operation**
 The SLEEP function is used to decrease energy use while you sleep (and don't need the same temperature settings to stay comfortable). This function can only be activated via remote control. And the Sleep function is not available in FAN or DRY mode.
 Press the SLEEP button when you are ready to go to sleep. When in COOL mode, the unit will increase the temperature by 1°C after 1 hour, and will increase an additional 1°C after another hour. When in HEAT mode, the unit will decrease the temperature by 1°C after 1 hour, and will decrease an additional 1°C after another hour.
 The sleep feature will stop after 8 hours and the system will keep running with final situation.

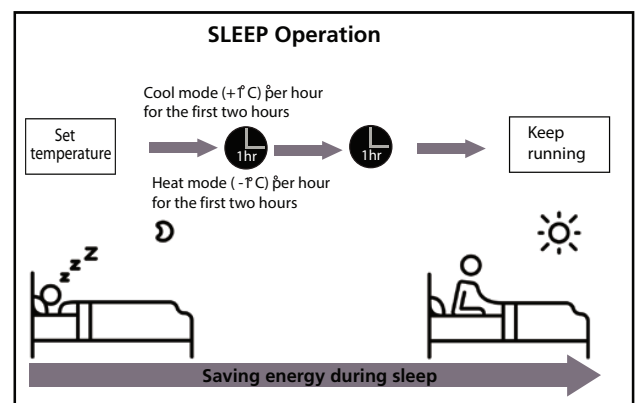

NOTE:

For multi-split air conditioners, the following functions are not available:
 Active clean function, Silence feature, Breeze away function, Refrigerant leakage detection function and Eco feature.

• Setting Angle of Air Flow

Setting vertical angle of air flow

While the unit is on, use the SWING/DIRECT button on remote control to set the direction (vertical angle) of airflow. Please refer to the Remote Control Manual for details.

NOTE ON LOUVER ANGLES

When using COOL or DRY mode, do not set louver at too vertical an angle for long periods of time. This can cause water to condense on the louver blade, which will drop on your floor or furnishings.

When using COOL or HEAT mode, setting the louver at too vertical an angle can reduce the performance of the unit due to restricted air flow.

Setting horizontal angle of air flow

The horizontal angle of the airflow must be set manually. Grip the deflector rod (See Fig.B) and manually adjust it to your preferred direction.

For some units, the horizontal angle of the airflow can be set by remote control. please refer to the Remote Control Manual.

Manual Operation(without remote)

CAUTION

The manual button is intended for testing purposes and emergency operation only. Please do not use this function unless the remote control is lost and it is absolutely necessary. To restore regular operation, use the remote control to activate the unit. Unit must be turned off before manual operation.

To operate your unit manually:

1. Open the front panel of the indoor unit.
2. Locate the **MANUAL CONTROL button** on the right-hand side of the unit.
3. Press the **MANUAL CONTROL button** one time to activate FORCED AUTO mode.
4. Press the **MANUAL CONTROL button** again to activate FORCED COOLING mode.
5. Press the **MANUAL CONTROL button** a third time to turn the unit off.
6. Close the front panel.

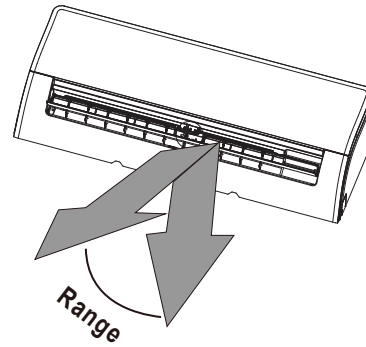

NOTE: Do not move louver by hand. This will cause the louver to become out of sync. If this occurs, turn off the unit and unplug it for a few seconds, then restart the unit. This will reset the louver.

Fig. A

CAUTION

Do not put your fingers in or near the blower and suction side of the unit. The high-speed fan inside the unit may cause injury.

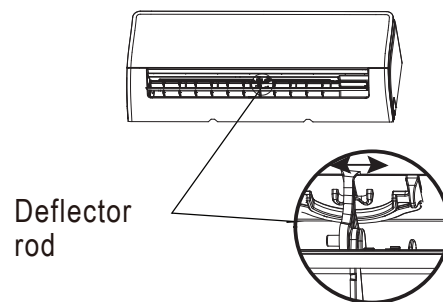
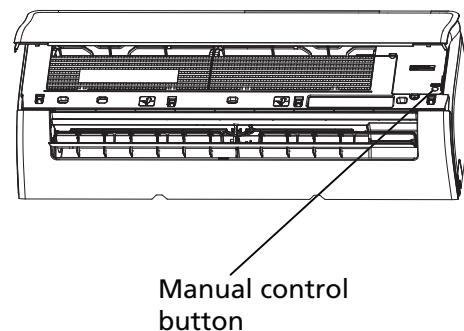

Fig. B



CARE & MAINTENANCE

GENERAL MAINTENANCE

Cleaning Your Indoor Unit

BEFORE CLEANING OR MAINTENANCE

ALWAYS TURN OFF YOUR AIR CONDITIONER SYSTEM AND DISCONNECT ITS POWER SUPPLY BEFORE CLEANING OR MAINTENANCE.

CAUTION

Only use a soft, dry cloth to wipe the unit clean. If the unit is especially dirty, you can use a cloth soaked in warm water to wipe it clean.

- **Do not** use chemicals or chemically treated cloths to clean the unit
- **Do not** use benzene, paint thinner, polishing powder or other solvents to clean the unit. They can cause the plastic surface to crack or deform.
- **Do not** use water hotter than 40°C to clean the front panel. This can cause the panel to deform or become discolored.

Cleaning Your Air Filter

A clogged air conditioner can reduce the cooling efficiency of your unit, and can also be bad for your health. Make sure to clean the filter once every two weeks.

1. Lift the front panel of the indoor unit.
2. First press the tab on the end of filter to loosen the buckle, lift it up, then pull it towards yourself.
3. Now pull the filter out.
4. If your filter has a small air freshening filter, unclip it from the larger filter. Clean this air freshening filter with a hand-held vacuum.
5. Clean the large air filter with warm, soapy water. Be sure to use a mild detergent.

6. Rinse the filter with fresh water, then shake off excess water.
7. Dry it in a cool, dry place, and refrain from exposing it to direct sunlight.
8. When dry, re-clip the air freshening filter to the larger filter, then slide it back into the indoor unit.
9. Close the front panel of the indoor unit.

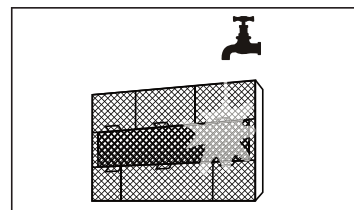
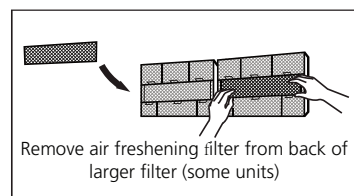
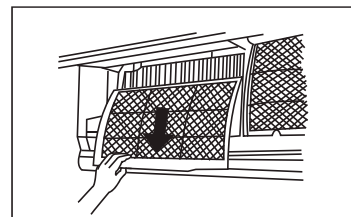
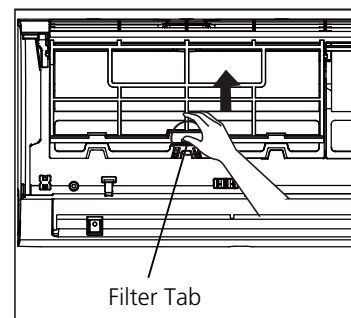

CAUTION

Do not touch air freshening (Plasma) filter for at least 10 minutes after turning off the unit.



Make sure have your appliance professionally serviced once per year, failing to do so may decrease the operational efficiency or increase energy consumed.



Failure to clean the filters regularly can cause condensation to form and drip from the indoor unit when operated in cooling mode during humid conditions. If you need more filters, please contact Rinnai.

CAUTION

- Before changing the filter or cleaning, turn off the unit and disconnect its power supply.
- When removing filter, do not touch metal parts in the unit. The sharp metal edges can cut you.
- Do not use water to clean the inside of the indoor unit. This can destroy insulation and cause electrical shock.
- Do not expose filter to direct sunlight when drying. This can shrink the filter.

Air Filter Reminders (Optional)

Air Filter Cleaning Reminder

After 240 hours of use, the display window on the indoor unit will flash "CL." This is a reminder to clean your filter. After 15 seconds, the unit will revert to its previous display.

To reset the reminder, press the **LED** button on your remote control 4 times, or press the **MANUAL CONTROL** button 3 times. If you don't reset the reminder, the "CL" indicator will flash again when you restart the unit.

Air Filter Replacement Reminder

After 2,880 hours of use, the display window on the indoor unit will flash "nF." This is a reminder to replace your filter. After 15 seconds, the unit will revert to its previous display.

To reset the reminder, press the **LED** button on your remote control 4 times, or press the **MANUAL CONTROL** button 3 times. If you don't reset the reminder, the "nF" indicator will flash again when you restart the unit.

CAUTION

- Any maintenance and cleaning of outdoor unit should be performed by an authorized dealer or a licensed service provider.
- Any unit repairs should be performed by an authorized dealer or a licensed service provider.

Maintenance – Long Periods of Non-Use

If you plan not to use your air conditioner for an extended period of time, do the following:

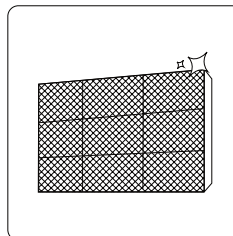

Clean all filters

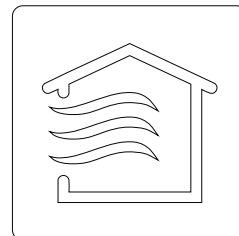

Turn on FAN function until unit dries out completely



Turn off the unit and disconnect the power

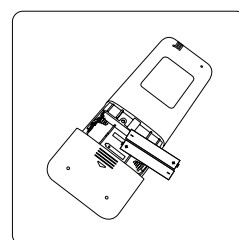

Remove batteries from remote control

Maintenance – Pre-Season Inspection

After long periods of non-use, or before periods of frequent use, do the following:

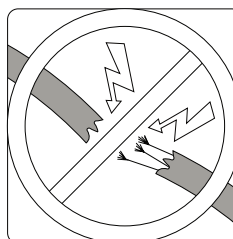

Check for damaged wires

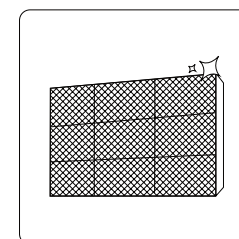

Clean all filters



Check for leaks

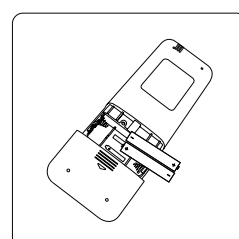

Replace batteries

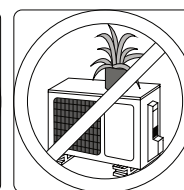
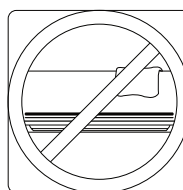

Make sure nothing is blocking all air inlets and outlets



SAFETY PRECAUTIONS

If ANY of the following conditions occurs, turn off your unit immediately!

- The power cord is damaged or abnormally warm
- You smell a burning odor
- The unit emits loud or abnormal sounds
- A power fuse blows or the circuit breaker frequently trips
- Water or other objects fall into or out of the unit

DO NOT ATTEMPT TO FIX THESE YOURSELF! CONTACT AN AUTHORIZED SERVICE PROVIDER IMMEDIATELY!

Common Issues

The following problems are not a malfunction and in most situations will not require repairs.

Issue	Possible Causes
Unit does not turn on when pressing ON/OFF button	The Unit has a 3-minute protection feature that prevents the unit from overloading. The unit cannot be restarted within three minutes of being turned off.
The unit changes from COOL/HEAT mode to FAN mode	The unit may change its setting to prevent frost from forming on the unit. Once the temperature increases, the unit will start operating in the previously selected mode again.
	The set temperature has been reached, at which point the unit turns off the compressor. The unit will continue operating when the temperature fluctuates again.
The indoor unit emits white mist	In humid regions, a large temperature difference between the room's air and the conditioned air can cause white mist.
Both the indoor and outdoor units emit white mist	When the unit restarts in HEAT mode after defrosting, white mist may be emitted due to moisture generated from the defrosting process.
The indoor unit makes noises	A rushing air sound may occur when the louver resets its position.
	A squeaking sound may occur after running the unit in HEAT mode due to expansion and contraction of the unit's plastic parts.
Both the indoor unit and outdoor unit make noises	Low hissing sound during operation: This is normal and is caused by refrigerant gas flowing through both indoor and outdoor units.
	Low hissing sound when the system starts, has just stopped running, or is defrosting: This noise is normal and is caused by the refrigerant gas stopping or changing direction.
	Squeaking sound: Normal expansion and contraction of plastic and metal parts caused by temperature changes during operation can cause squeaking noises.

Issue	Possible Causes
The outdoor unit makes noises	The unit will make different sounds based on its current operating mode.
Dust is emitted from either the indoor or outdoor unit	The unit may accumulate dust during extended periods of non-use, which will be emitted when the unit is turned on. This can be mitigated by covering the unit during long periods of inactivity.
The unit emits a bad odor	The unit may absorb odors from the environment (such as furniture, cooking, cigarettes, etc.) which will be emitted during operations.
	The unit's filters have become moldy and should be cleaned.
The fan of the outdoor unit does not operate	During operation, the fan speed is controlled to optimize product operation.
Operation is erratic, unpredictable, or unit is unresponsive	Interference from cell phone towers and remote boosters may cause the unit to malfunction. In this case, try the following: <ul style="list-style-type: none"> • Disconnect the power, then reconnect. • Press ON/OFF button on remote control to restart operation.

NOTE: If problem persists, contact a local dealer or your nearest customer service center. Provide them with a detailed description of the unit malfunction as well as your model number.

Troubleshooting

When troubles occur, please check the following points before contacting a repair company.

Problem	Possible Causes	Solution
Poor Cooling Performance	Temperature setting may be higher than ambient room temperature	Lower the temperature setting
	The heat exchanger on the indoor or outdoor unit is dirty	Clean the affected heat exchanger
	The air filter is dirty	Remove the filter and clean it according to instructions
	The air inlet or outlet of either unit is blocked	Turn the unit off, remove the obstruction and turn it back on
	Doors and windows are open	Make sure that all doors and windows are closed while operating the unit
	Excessive heat is generated by sunlight	Close windows and curtains during periods of high heat or bright sunshine
	Too many sources of heat in the room (people, computers, electronics, etc.)	Reduce amount of heat sources
	Low refrigerant due to leak or long-term use	Check for leaks, re-seal if necessary and top off refrigerant
SILENCE function is activated (optional function)	SILENCE function can lower product performance by reducing operating frequency. Turn off SILENCE function.	

Problem	Possible Causes	Solution
The unit is not working	Power failure	Wait for the power to be restored
	The power is turned off	Turn on the power
	The fuse is burned out	Replace the fuse
	Remote control batteries are dead	Replace batteries
	The Unit's 3-minute protection has been activated	Wait three minutes after restarting the unit
	Timer is activated	Turn timer off
The unit starts and stops frequently	There's too much or too little refrigerant in the system	Check for leaks and recharge the system with refrigerant.
	Incompressible gas or moisture has entered the system.	Evacuate and recharge the system with refrigerant
	The compressor is broken	Replace the compressor
	The voltage is too high or too low	Install a manostat to regulate the voltage
Poor heating performance	The outdoor temperature is extremely low	Use auxiliary heating device
	Cold air is entering through doors and windows	Make sure that all doors and windows are closed during use
	Low refrigerant due to leak or long-term use	Check for leaks, re-seal if necessary and top off refrigerant
Indicator lamps continue flashing	The unit may stop operation or continue to run safely. If the indicator lamps continue to flash or error codes appear, wait for about 10 minutes. The problem may resolve itself. If not, disconnect the power, then connect it again. Turn the unit on. If the problem persists, disconnect the power and contact your nearest customer service center.	
Error code appears and begins with the letters as the following in the window display of indoor unit:	<ul style="list-style-type: none"> • E(x), P(x), F(x) • EH(xx), EL(xx), EC(xx) • PH(xx), PL(xx), PC(xx) 	

NOTE: If your problem persists after performing the checks and diagnostics above, turn off your unit immediately and contact an authorized service center.

INSTALLATION RECORD - INSTALLER DETAILS

Company Name: _____

Company Address: _____

Telephone: _____

Mobile Phone: _____

Email: _____

Certificate of Compliance / Certification No. _____

Authorised Persons - Licence No. _____

Installers Name: _____

Installers Signature: _____

Installation Date: _____

INSTALLATION RECORD - SYSTEM DETAILS

Model Number : _____

Serial Number Indoor Unit: _____

Serial Number Outdoor Unit: _____

Installation Address: _____

CUSTOMER CARE PROGRAM

Please ensure you register your product warranty on line at rinnai.com.au.

The Rinnai Customer Care Program is designed to help you get the most out of your new system.

Service and maintenance in accordance with the Service Maintenance Schedules on page 17 is essential in ensuring the prolonged useful life of your system, and help ensure it operates at optimum efficiency. We may contact you before each winter or summer season with preferential offers for preventative maintenance services which will keep your Rinnai system in great condition.



Service maintenance is not covered under warranty and is a chargeable service. All units must have safe and reasonable access and be installed in compliance with the installation instructions supplied with the unit. Some installations may require two service personnel to attend, in accordance with Health and Safety requirements.

Also note that all refrigerated air conditioning systems have air filters that require regular inspection and cleaning. Please refer to "Cleaning Your Air Filter" on page 11

SERVICE MAINTENANCE SCHEDULE - NON DUCTED AIR CONDITIONING SYSTEMS

Your Rinnai Air Conditioning System should be maintained annually after the date of installation by a qualified licensed technician in accordance with the Schedule below. Failure to do so during the product warranty period may void your warranty. This periodic service and maintenance will prolong the useful life of the unit, and help keep it running safely and at optimum efficiency.

Date of Installation	/ /		Installed By:			
Service Year	1	2	3	4	5	6
Service Date	/ /	/ /	/ /	/ /	/ /	/ /
Service Company / Technician						
Ambient Temperature at CDU (°C)						
ELECTRICAL						
Wiring, Electrical connections						
Fan Motors						
Capacitors (if applic)						
Printed circuit boards						
MAJOR COMPONENTS						
Outdoor unit clearances						
Outdoor unit condensate tray						
Outdoor unit condensate drain						
Outdoor unit fixing						
Indoor unit condensate tray						
Indoor unit condensate drain / pump						
Refrigerant charge						
Refrigeration connections						
Fan assemblies						
Return Air grille & filters						
CONTROLS						
Louver operation						
Remote operation						
System Operation						
Sequence of operation						
Return Air Temp - Cooling/ Heating	°C	°C	°C	°C	°C	°C
Outlet Air Temp - Cooling / Heating	°C	°C	°C	°C	°C	°C
Outdoor unit - Liquid line pressure	kPa	kPa	kPa	kPa	kPa	kPa
Outdoor unit - Suction line pressure	kPa	kPa	kPa	kPa	kPa	kPa
GENERAL INSTALLATION-RELATED AND 3rd PARTY COMPONENTS (NOT RINNAI PRODUCTS) *						
Airflow through system						
Refrigerant pipework						
Safety tray						
Wall mounting						
CONSUMABLES **						
Capacitors						
Filters						
Batteries (If applic)						
* Installation and other field-supplied components are not covered by Rinnai Product Warranty. These include, but are not limited to, control wiring, refrigerant gas and electrical connections to the appliance. These should be inspected as they can affect the performance, reliability and safety of the system.						
** Units contain consumable items that may require periodic replacement and are not covered by Rinnai product warranty (e.g. filters, capacitors and batteries)						
ACTION CODES						
Inspected - Working Correctly - No Action Required	Adjusted Part	Cleaned Part	Replaced Part	Repaired Part	Referred to Installer	
✓	A	C	R	RP	RI	

WARRANTY

TERMS OF WARRANTY – AUSTRALIA

Rinnai Australia Pty. Ltd. ABN 74 005 138 769, 82-88 Mills Road, Braeside, Victoria, 3195.

1 DEFINITIONS

The terms listed below shall have the following meanings:

- 1 **“Authorised Service Representative”** means an independent service contractor authorised by Rinnai or Rinnai service personnel.
- 2 **“Rinnai”** means Rinnai Australia Pty Ltd (ABN 74 005 138 769) and any related company.
- 3 **“Certificate(s) of Compliance”** means certificate(s) issued by licensed personnel (including plumbers, refrigeration mechanics, electricians or other relevant tradespeople) to certify that any prescribed works comply with applicable regulatory requirements.
- 4 **“Certificate(s) of Occupancy”** means certificate(s) issued by the local government authority (or similar organisation) which certifies that a home can be occupied.
- 5 **“Installation Site”** means the site at which the Product is originally installed.
- 6 **“Normal Business Hours”** means 8:30am to 5:00pm Monday to Friday, excluding public holidays.
- 7 **“Operating/Installation Instructions”** means the user manual or other documentation which provides detailed instructions on the proper operation and maintenance of the Product.
- 8 **“Other Applications”** means any Product used for purposes other than Residential & Light Commercial Applications. Other Applications may include but are not limited to factory, IT/Server room, telephone exchange, processing area (e.g. bakery, kitchen, warehouse, swimming pool, agricultural facilities such as a nursery). Any Product which has been installed, for whatever purpose, as a retrofit component to an existing system, will also be classed as being part of an “Other Application” regardless of the purpose of use of the existing system into which such product has been installed.
- 9 **“Purchaser”** means the end user of the Product, the person named as owner in the Warranty certificate, the holder of the Proof of Purchase or the holder of a property transfer document where the Product is included as part of the chattels.
- 10 **“Product”** means the equipment purchased by the Purchaser and described in Section 2 of this document.
- 11 **“Proof of Purchase”** means a Tax Invoice or Receipt in respect of the Product. In the case of new constructions, a Certificate of Occupancy or a Certificate of Compliance that details the date of installation or commissioning will suffice.
- 12 **“Qualified Installer”** means the qualified installation contractor who is responsible for performing the installation work in the manner prescribed by local and statutory regulations, including compliance with any relevant and to Rinnai specifications, including Australian Standards.
- 13 **“Residential & Light Commercial Applications”** means any Product for use in residential or light commercial applications where
 - a) the Product is solely used for the purpose of human comfort; and
 - b) the ambient temperature of the space the Product is intended to heat or cool is influenced solely or primarily by natural exterior weather conditions rather than by man-made or mechanical heat sources.

Examples of Residential & Light Commercial Applications include, homes, offices, hotels, apartments, nursing homes, hospitals, health care premises, shopping centres, and retail stores.

2 TERMS OF WARRANTY

2.1 Subject to the terms of warranty set out in this document, and effective from the date of completion of installation, the product is warranted to be free from defects in materials & factory workmanship for the period set out in the table below:

	PRODUCT GROUPS	PARTS	LABOUR
Residential and Light Commercial	Evaporative Coolers & Ducted Gas Heaters (excluding Compact Classic Series)	5 Years *Extended 4 Years Option	5 Years *Extended 4 Years Option
	Ducted Gas Heaters - Compact Classic Series	3 Years	3 Years
	Refrigerated Air Conditioning Products	7 Years	7 Years
	VRF Air Conditioning Products	5 Years	5 Years
	Ducted Gas Heaters - Heat Exchangers and Burners Evaporative Coolers - Structural components only	10 Years	N/A
	Portable Air conditioning ⁽¹⁾ / Dehumidifier ⁽¹⁾ / Air Purifier ⁽¹⁾	2 Years	N/A
	Electric Panel Heaters ⁽¹⁾	7 Years	N/A
	Electric Fire Heater	5 Years	5 Years
	Outdoor Radiant Heater	3 Years	1 Year
	Wi-Fi Devices	1 Year	1 Year
Commercial	Refrigerated Air Conditioning Products	2 Years	1 Year
Other Applications	All Product Groups	2 Years	1 Year
After Market	Spare Parts	1 Year	N/A
*Extended Warranty Option	Up to 4 year extended warranty (in addition to the standard warranty period listed above) applies on selected products when you opt in to the Rinnai Service Advantage program. This program has terms and conditions, including the requirement for scheduled servicing of the product by Rinnai. To participate in the program you must register your product online at: www.rinnai.com.au/support-resources/warranty-registration/ within the first 12 months of the product being installed.		

⁽¹⁾ To make a claim under this warranty, please contact your place of purchase within the warranty period.

- 2.2 Rinnai will determine in its sole discretion, which classification the Product fits into and the corresponding Warranty that shall apply.
- 2.3 An Authorised Service Representative will repair or replace, at its option, the Product or any part of the Product that its examination shows to be defective. The repair or replacement shall be performed during Normal Business Hours by an Authorised Service Representative. Repair by persons other than an Authorised Service Representatives may void the Warranty.
- 2.4 Alternatively to clause 2.3 above, Rinnai can at its discretion elect to pay you an amount equivalent to the cost of repairing or replacing the Product.
- 2.5 If Rinnai provides you with either the replacement costs or replacement product, ownership of the original Product shall immediately transfer to Rinnai.
- 2.6 Rinnai is responsible for reasonable costs associated with legitimate warranty claims, including call-out of an Authorised Service Representative to inspect the Product. Rinnai is not responsible for:
- costs for tradespeople engaged by you that are not Rinnai Authorised Service Representatives.
 - any costs, including call out costs for a Rinnai Authorised Service Representatives, associated with a Product which is determined upon inspection not to be covered by this warranty.
- 2.7 Rinnai will reimburse any reasonable costs associated with making a legitimate warranty claim against Rinnai which are not otherwise specified above.
- 2.8 The Warranty of the Product requires that, in addition to all other conditions, the Purchaser conducts regular and/or preventative maintenance as may be specified by the Operating/Installation Instructions or otherwise directed by Rinnai and required by the level of usage and the usage environment, including the use of correct and uncontaminated refrigerants and lubricants. Refrigeration, plumbing and electrical works must be undertaken by licensed personnel.
- 2.9 Where a Product or failed component is replaced under warranty, the time remaining on the original Product warranty period will continue to apply and the replacement product or part will be subject to the original warranty period only.

3 CONDITIONS OF WARRANTY

- 3.1 The Purchaser may only obtain the benefit of the Warranty if the Purchaser:
- maintains and has the Product serviced in accordance with the instructions set out in the service section of the relevant Service or Owner's Manual;
 - complies with clause 7 "Purchaser's Responsibilities";
 - notifies Rinnai within 30 days of a defect occurring or, in the case of a latent defect, becoming apparent, that a claim is being made under this Warranty; and
 - provides, in support of the claim made under this Warranty, a proof of date of completion of installation.
- 3.2 This document (and any statutory consumer guarantees) represents the only Warranty given by Rinnai in respect of the Product. No other person or organisation is authorised to offer any alternative warranty on behalf of Rinnai.
- 3.3 If the date of completion of installation cannot be established to Rinnai's satisfaction, the date shall be deemed to be 2 months after the date of manufacture or date of sale by Rinnai, whichever is the latter.
- 3.4 This warranty applies to Products which are manufactured on or after the date of publication of this warranty but before the next date of publication of this warranty.

4 EXCLUSIONS

- 4.1 This Warranty **DOES NOT** cover:
- damage, problems or failure resulting from improper operation and/or inadequate maintenance by the Purchaser (refer Purchaser's Responsibilities section below);
 - damage, problems or failure resulting from improper or faulty installation. The Product must be installed by a Qualified Installer in accordance with applicable regulations. Where applicable, Certificate(s) of Compliance must be obtained by the purchaser from the Qualified Installer and presented to the Authorised Service Representative;
 - damage, problems or failure caused by factors external to the Product including, but not limited to, faulty or poor external electrical wiring, incorrect or faulty power supply, voltage fluctuations, over voltage transients or electromagnetic interference, inadequate or faulty gas, drainage services, or water services, including water pressure, and non-potable water;
 - damage, problems or failure caused by acts of God, fire, wind, lightning, flood, storm, hail storm fallout, vandalism, earthquake, war, civil insurrection, misuse, abuse, negligence, accident, pests, animals, pets, vermin, insects, spiders/bugs or entry of foreign objects or matter into the Product such as dirt, debris, soot or moisture;
 - damage, problems or failure caused by environmental conditions including, but not limited to, excessive moisture, salt or other corrosive substances or atmospheric conditions;
 - Product which has been installed in a portable or mobile building, structure or application including, but not limited to, a caravan, boat or trailer;
 - Product which has been re-installed at a location other than the original site;
 - any consumable item supplied with the Product including, but not limited to, an air filter, battery, fan belt, igniter or cooler pad;
 - installation of third-party components that may be attached to the Product. These include, but are not limited to, control wiring, ducting, return air filter(s) grille, register, diffuser, zone motors, controls/thermostats, pipe work and fabricated or added components. These items remain solely the responsibility of the Qualified Installer;
 - installations where electrics/electronics may be subjected to moisture/chemicals (e.g. swimming pools or nurseries);
 - any repair, which is needed as a result of an accident, misuse, abuse or negligence;
 - Product that is utilised in an environment (indoor and outdoor) outside its specified operating range; and
 - fair wear and tear to the Product.
 - On-site labour warranty on portable (non-fixed installation) Products – In respect of such Products the Purchaser must return the Product to the supplier for repair or replacement).

5 LIMITATIONS

- 5.1 Third parties are often involved in providing advice to consumers about the climate control solutions best suited to the consumer's needs. Any advice or recommendations given by such parties, including advice about Product fitness for purpose and overall system design, sizing and application are not the responsibility of Rinnai. This includes but is not limited to the heat load calculations, airflow and system balancing.
- 5.2 This Warranty does not apply to any Product installed at an Installation Site which is outside Australia.
- 5.3 Except where inconsistent with the purchaser's statutory rights and the rights given by this Warranty, all liabilities of Rinnai for any direct, special, indirect or consequential loss or damage, any damage or expense for personal injury or any loss or destruction of property, arising directly or indirectly from the use or inability to use the Product or any of its parts and/or servicing the Product, are expressly excluded.

6 TRAVEL, TRANSPORT & ACCESS COSTS

- 6.1 The Purchaser must pay freight charges, in-transit insurance expenses and travelling costs for repairs/replacements under this Warranty, that are required to be performed 50km from the nearest Rinnai branch or Authorised Service Representative.
- 6.2 Subject to clause 6.3, Rinnai will pay freight charges, in-transit insurance expenses and travelling costs for repairs/replacements that are required to be performed less than 50km from the nearest Rinnai branch or Authorised Service Representative, subject to the following:
- Rinnai will arrange for such repairs/replacements and make any payment directly to the third party to provide the freight, in-transit insurance or travel services; or
 - if Rinnai considers appropriate, it will authorise the Purchaser in writing to pay for the relevant freight charges, in-transit insurance expenses or travelling costs and then, upon provision by the Purchaser to Rinnai of a tax invoice showing those costs have been incurred, reimburse the Purchaser for such costs which are within the terms of the authorisation. If the Purchaser pays for the relevant freight charges, in-transit insurance expenses or travelling costs without written authorisation from Rinnai, Rinnai will not reimburse the Purchaser for such costs.
- 6.3 The Purchaser must pay all costs and expenses in respect of:
- any service call out fee if the Product is not accessible for service
 - making the Product accessible for service, for example, restricted access or working at heights, or the labour cost for an additional person due to OHS requirements.
 - providing a safe working environment for installation, service, maintenance or repair of the Product;
 - any surcharge applicable in respect of supplying replacement parts outside Normal Business Hours; and
 - any other costs and expenses in relation to claiming the Warranty that is not covered by clause 6.2.

7 PURCHASER'S RESPONSIBILITIES

- 7.1 The Purchaser must operate and maintain the Product in accordance with the Operating Instructions and service maintenance schedule, including conducting an appropriate number of services to the unit during the Warranty period, based on usage and the usage environment including but not limited to;
- regularly cleaning the air filter(s) and replacing them where necessary;
 - replacing expired batteries or other consumables as required;
 - ensuring that the condensate drain is kept clean and clear of obstructions.

HOW TO MAKE A WARRANTY CLAIM:

If you wish to make a warranty claim in respect of any Portable Product, please return it to the place of purchase, or if that is not possible, contact Rinnai to enquire about alternative arrangements.

If you wish to make a warranty claim in respect of any fixed Product, please contact Rinnai on the details set out below to make arrangements for an Authorised Service Representative to inspect the product.

As per clause 2.6 of the Terms and Conditions of Warranty, purchasers are responsible for the costs of any repair and/or call out fee where, on inspection, the alleged defect is found by Rinnai's Authorised Service Representative not to be covered by this warranty or any statutory consumer guarantee applicable to the Product.

The Terms and Conditions of Warranty contain important information about your rights and obligations under this warranty. Please read them fully and carefully before making a claim.

NOTICE TO CONSUMERS UNDER AUSTRALIAN CONSUMER LAW

Our goods come with guarantees that cannot be excluded under the Australian Consumer Law. You are entitled to a replacement or refund for a major failure and compensation for any other reasonably foreseeable loss or damage. You are also entitled to have the goods repaired or replaced if the goods fail to be of acceptable quality and the failure does not amount to a major failure.

Our services come with guarantees that cannot be excluded under the Australian Consumer Law. For a major failure with the service, you are entitled to cancel your service contract with us and obtain a refund for the unused portion, or to compensation for its reduced value. You are also entitled to be compensated for any other reasonably foreseeable loss or damage. If the failure does not amount to a major failure you are entitled to have problems with the service rectified in a reasonable time and, if this is not done, to cancel your contract and obtain a refund for the unused portion of the contract.

The benefits provided by this Warranty are in addition to any other rights and remedies available to a consumer under the Australian Consumer Law and any other law which may apply to the goods and or services.

NOTES





NOTES

Rinnai Australia Pty Ltd

ABN 74 005 138 769 | AU45204

82-88 Mills Road, Braeside, Victoria, 3195
P.O. Box 460, Braeside, Victoria, 3195
Tel: (03) 9271 6625

Customer Support

Tel: 1300 555 545*

Monday to Friday, 8.00 am to 5.00 pm EST.

**Cost of a local call may be higher from a mobile phone.
(National calls from public phones in Australia are free.)*

For further information visit www.rinnai.com.au
or email enquiry@rinnai.com.au

Rinnai has a Service and Spare Parts network with personnel who are fully trained and equipped to give the best service on your Rinnai appliance. If your appliance requires service, please call Customer Support. Rinnai recommends that this appliance be serviced once a year.

With our policy of continuous improvement, we reserve the right to change, or discontinue at any time, specifications or designs without notice.