

This system shall be installed in accordance with:

- Manufacturer's Installation Instructions
- Current AS/NZS 3500
- All applicable local rules and regulations including local OH&S requirements

This system must be installed, commissioned and serviced by an Authorised Person.

The solar hot and solar cold pipes between the solar storage tank and the solar collector(s) must be copper tube. Fittings used to join these pipes must use metallic materials to achieve sealing. Plastic pipe and fittings must not be used as they are not suitable for the high temperatures and pressures that may occur. Failure of plastic pipe and/or fittings can lead to the release of high temperature water and can cause severe flooding and water damage.



IMPORTANT

Not suitable as a pool or spa heater.



The Australian Gas Association
All Rinnai gas products
are A.G.A. certified.

Certified Product



WaterMark
AS3498 Lic W169
SAI Global

Certified Product



WaterMark
AS3498 Lic W208
SAI Global



N10378



AS/NZS 2712
Lic No.1849
SAI Global

TABLE OF CONTENTS

Warnings and Important Information	4
Safety and Regulatory Information	4
Scald Hazards	5
Operation Principle	6
Safety Devices	7
Excessive Discharge from Safety Devices	7
Gas Boosters	8
Hydrogen Gas	8
Water Temperature	8
Turning Off the Water Heating System	8
Turning On the Water Heating System	8
Water Quality	9
Draining and Filling the Water Heating System	9
Maintenance and Regular Care	9
Servicing and Repair	9
Save a Service Call	10
Specifications	12
General	12
Cylinder Weights	12
System Dimensions - Stainless Steel Cylinders	13
System Dimensions - Glass Lined Cylinders	14
Solar Collectors	15
Gas Boosters	16
Installation - All Systems	17
Regulations and Occupation Health and Safety (OH&S)	17
Location	17
Water Pipes, Fittings and Insulation	18
Water Supply	18
Hot Water Delivery Temperature	19
Valves and Fittings	19
System Orientation and Inclination	20
Roof Mounting Options	21
Standard Installation	24
Roof pitch greater than 30°	29
Framed Installations - Flat, Reverse and Side Pitch	30
Framed Installations - Cyclone Frame	30

180 Litre Stainless Steel Cylinder with 1 Collector - IKS180CCT01C	32
180 Litre Stainless Steel Cylinder with 2 Collectors - IKSUNICCT23C	34
330 Litre Stainless Steel Cylinder with 2 Collectors - IKS330CCT02C	36
330 Litre Stainless Steel Cylinder with 3 Collectors - IKSUNICCT23C	38
200 Litre Glass Lined Cylinder with 1 Collector - IKV200CCT01C	40
200 Litre Glass Lined Cylinder with 2 Collectors - IKVUNICCT23C	42
330 Litre Glass Lined Cylinder with 2 Collectors - IKV330CCT02C	44
330 Litre Glass Lined Cylinder with 3 Collectors - IKVUNICCT23C	46
Installation - Gas Boosted Systems	48
Gas Booster Location	48
Gas Supply	48
Hot Water Delivery Temperature	48
SMARTSTART®	48
System Using Rinnai SmartStart	49
Gas Booster Clearances	50
Installation Procedure	51
Filling the System	52
Pre Solar Heating Checks	52
Solar Heating	53
Finishing the Installation	53
Draining Instructions	53
Installation - Electric Boosted Systems	54
Installation Procedure	54
Filling the System	55
Pre Solar Heating Checks	56
Solar Heating	56
Finishing the Installation	56
Draining Instructions	56
Installation Record	57
Notes	58

WARNINGS AND IMPORTANT INFORMATION

SAFETY AND REGULATORY INFORMATION



DO NOT operate this system before reading the manufacturer's instructions.

This appliance must be installed, commissioned and serviced by an authorised person in accordance with all applicable local rules and regulations.

Access covers of water heating system components will expose 240V wiring and MUST be removed by an authorised person.

This appliance is not intended for use by persons (including children) with reduced physical, sensory or mental capabilities, or lack of experience and knowledge, unless they have been given supervision or instruction concerning use of the appliance by a person responsible for their safety.

For continued safety of this appliance it must be installed, operated and maintained in accordance with the manufacturer's instructions.

Children should be supervised to ensure they DO NOT play with the appliance.

Any power leads from the water heater system components MUST BE plugged into an external weatherproof electrical outlet. If the power supply cord of any water heating components is damaged, it MUST BE replaced by an authorised person in order to avoid a hazard, using genuine replacement parts available from Rinnai. Take care not to touch the power plugs with wet hands.

Care should be taken not to touch the pipe work as it may be HOT!

The pipes between the solar collectors and storage cylinder MUST BE copper or an equivalent metallic material specified by Rinnai. Plastic pipe is NOT suited to the water temperatures and pressures that may occur in the system.

DO NOT place articles on or against this appliance.

DO NOT store chemicals or flammable materials near this appliance.

DO NOT operate with collectors or covers removed from this appliance.

NEVER use a flammable spray such as hair spray, lacquer, paint, etc near this unit as this may cause a fire.

NOTICE TO VICTORIAN CONSUMERS

This appliance must be installed by a person licensed with the Victorian Building Authority.

Only a licensed person will have insurance protecting their workmanship.

So make sure you use a licensed person to install this appliance and ask for your Compliance Certificate.

For Further information contact the Victorian Building Authority on 1300 815 127.

SCALD HAZARDS



HOT WATER CAN CAUSE SCALDS.

CHILDREN, DISABLED, ELDERLY AND THE INFIRM ARE AT THE HIGHEST RISK OF BEING SCALDED.

FEEL WATER TEMPERATURE BEFORE BATHING OR SHOWERING.

SCALDS FROM HOT WATER TAPS CAN RESULT IN SEVERE INJURIES TO YOUNG CHILDREN.

SCALDS OCCUR WHEN CHILDREN ARE EXPOSED DIRECTLY TO HOT WATER WHEN THEY ARE PLACED INTO A BATH WHICH IS TOO HOT.

ALWAYS.....

Test the temperature of the water with your elbow before placing your child in the bath, also carefully feel water before bathing or showering yourself.

Supervise children whenever they are in the bathroom.

Make sure that the hot water tap is turned off tightly.

CONSIDER.....

Installing child proof tap covers or child resistant taps. Both approaches will prevent a small hand being able to turn on the tap.

Installing tempering valves or thermostatic mixing valves which reduce the hot water temperatures delivered to the taps. Your local plumbing authority may already require that these be fitted. Contact your installer or local plumbing authority if in doubt.

NEVER....

Leave a toddler in the care of another child. They may not understand the need to have the water temperature set at a safe level.

OPERATION PRINCIPLE

Close coupled systems are designed to have the solar collectors on the roof and the storage cylinder above the collectors, all mounted using available mounting brackets. Electric and gas boosted models are available. The system comprises of a hot water storage cylinder and solar collectors. Close coupled solar systems use the thermosyphon principle to circulate the water through the collectors and then to the storage cylinder without the need for a pump.

Supplementary heating is provided if insufficient heat is available from sun (such as during cloudy or rainy weather or during winter months) either via an electric heating element located inside the storage cylinder or via a gas booster located external to the storage cylinder. The following diagrams illustrates the Close Coupled Solar Hot Water Systems set up for electric and gas boosting.

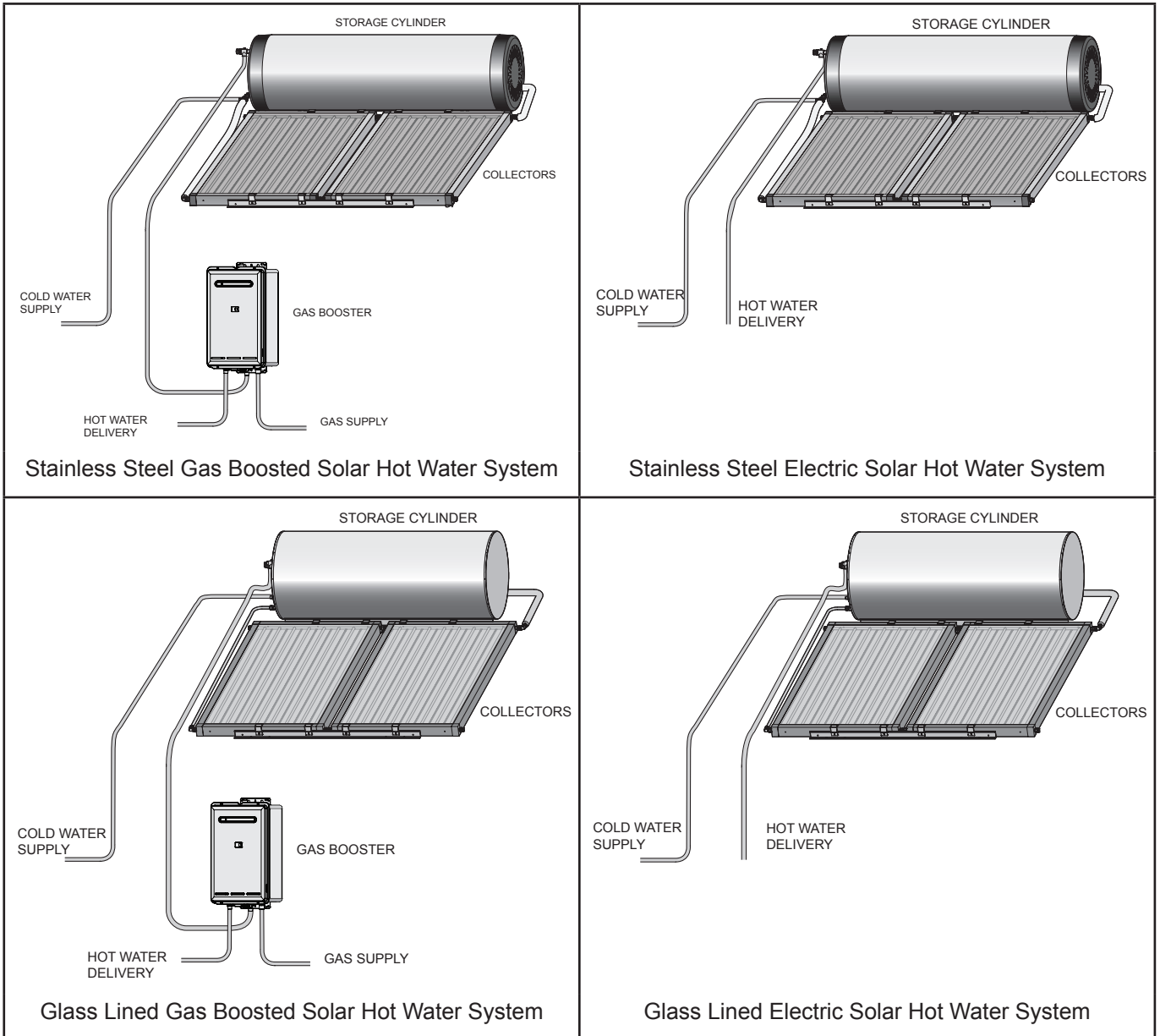

SAFETY DEVICES

The water heating system is supplied with various safety devices including temperature sensors, overheat sensors and switches and a Pressure & Temperature Relief (PTR) valve. These devices must not be tampered with or removed. The water heating system must not be operated unless each of these devices is fitted and is in working order.



- DO NOT tamper with or remove safety devices.**
- DO NOT operate the water heater unless all safety devices are fitted and in working order.**
- DO NOT block or seal the PTR Valve and drain pipe.**

Pressure & Temperature Relief (PTR) Valve

This valve is located near the top of the water heater and is essential for safe operation. It is normal for the valve to release a small quantity of water through the drain line during heating.

However, continuous leakage of water from the valve and its drain line may indicate a problem with the water heater.

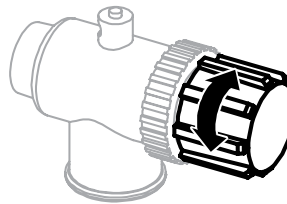

Twist cap until water flows from drain line

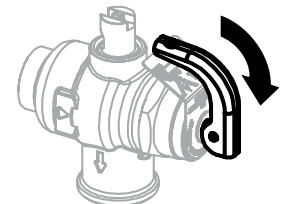

Lift lever until water flows from drain line (Lower lever gently!)



Never block the outlet of the PTR valve or it's drain line for any reason. The easing gear must be operated at least every 6 months to remove lime deposits and verify that it is not blocked. Failure to do this may result in the water heater failing.

If the valve does not discharge water when the easing gear lever is opened, or does not seal again when the easing gear is closed, attendance by an authorised person must be arranged without delay. The PTR valve is not serviceable.

EXCESSIVE DISCHARGE FROM SAFETY DEVICES

Pressure & Temperature Relief (PTR) Valve

It is normal and desirable that this valve allows a small quantity of water to be discharged during the heating cycle. If it discharges more than a bucket of water during a 24 hour period or discharges continuously there may be another problem.

If the valve dribbles continuously, try easing the valve gear for a few seconds as described above. This may dislodge any foreign matter and alleviate the problem.

If the valve discharges at high flows, especially at night, it may be as a result of the water pressure exceeding the design pressure of the water heater. Ask your installer to fit a Pressure Limiting Valve (PLV).



NEVER replace the PTR valve with one which has a higher pressure rating than is specified for your water heater.

Expansion Control Valve (ECV) - if fitted

It is normal and desirable that this valve allows a small quantity of water to be discharged during the heating cycle. If it discharges more than a bucket of water during a 24 hour period or discharges continuously there may be another problem.

If the valve leaks continuously, try easing the valve gear for a few seconds. This may dislodge any foreign matter and alleviate the problem. If this does not alleviate the problem contact Rinnai.

Operate the easing gear regularly to remove any lime deposits and to verify that it is not blocked.

GAS BOOSTERS

- Do not touch the flue outlet or do not insert any objects into the flue outlet.
- Keep flammable materials, spray cans, fuel containers, trees, shrubs and pool chemicals etc, well clear of the flue outlet.
- Do not use the gas types other than those designated on the data plate. For example, do not use Propane/ Butane gas mixtures on appliances marked Propane Gas.
- Do not use Propane Gas on appliances marked as Natural Gas and vice versa.

HYDROGEN GAS

In the case of systems using a vitreous enamel lined cylinder, if the hot water unit is not used for two weeks or more, a quantity of hydrogen gas, which is highly flammable, may accumulate in the water heater. To dissipate this safely, it is recommended that a non electrically operated hot tap be turned on for two minutes at a sink, basin, or bath, but not a dishwasher or other appliance. During this procedure there must be no smoking, open flame or any electrical appliance operating nearby. If hydrogen is discharged through the tap, it will probably make a sound like air escaping.

WATER TEMPERATURE

The water gets heated by the solar energy contributed from the sun and heats the water until the water at the base of the storage cylinder reaches approximately 65°C. At this time water at the hot outlet can be up to 88°C. Continued heating is prevented by the 'No Load' protection, a Thermo-arrestor (TA) valve that prevents water passing from the cylinder to the collectors. During periods of low solar gain, supplementary heating occurs.



To meet Australian regulatory requirements, supplementary heating must be operational.

TURNING OFF THE WATER HEATING SYSTEM

If you plan to be away for only a few nights, we suggest you leave the water heating system switched on. If it is necessary to switch off the water heater, do so as outlined below:

Electric Boosted Systems

- Switch off the electrical supply to the supplementary heating element. The switch is usually marked and located in the electricity meter box of the dwelling.

Gas Boosted systems

- Switch off the electric supply to the gas booster.

TURNING ON THE WATER HEATING SYSTEM

Electric Boosted system

- Switch on the electric supply to the supplementary heating element(s). The switch is usually marked and located in the electricity meter box of the dwelling.

Gas Boosted systems

- Switch on the electrical supply to the gas booster.

WATER QUALITY

The water quality of most public supplies is suitable for the water heating system. The water quality from bore wells is generally unsuitable for the water heating system. Refer to the separate warranty document for water quality parameters and how they affect the warranty conditions. If in doubt about the water quality, have it checked against the parameters listed in the warranty document. The system is not suitable as a pool or spa heater.

DRAINING AND FILLING THE WATER HEATING SYSTEM

Draining or filling normally occur only during installation or servicing and must be carried out by an authorised person.

MAINTENANCE AND REGULAR CARE

Operate the easing gear of the PTR as described in the section 'Safety Devices' on page 7.

SERVICING AND REPAIR

Our Servicing network personnel are fully trained and equipped to give the best service on your appliance. If your appliance needs service, ring one of the service contact numbers on the back of this booklet.

It is recommended that the system be serviced at least every 5 years.

The pressure and temperature relief valve and expansion control valve must be checked for performance or replaced by an authorised person at intervals not exceeding 5 years or more frequently in areas where the water is classified as scaling water (refer to the supplied warranty booklet).

It is recommended that the sacrificial anode fitted to Glass Lined cylinders be inspected every 5 years or more frequently in areas where there is a high incidence of water deposits. This does not apply to Stainless Steel cylinders. Anodes suited to hard and soft water, are available from Rinnai.

If the electric conduit, power supply cord or plug to the water heater is damaged, they must be replaced by an authorised person in order to avoid a hazard. The power supply cord and plug (if fitted) must be replaced by a genuine replacement part available from Rinnai.

SAVE A SERVICE CALL

Before contacting Rinnai for service, please follow the fault finding guide. If the problem persists or this information doesn't answer your questions, contact Rinnai on the phone number on the back of this manual

Service call outs attending to any condition or fault that is not related to Rinnai product or components may be chargeable.

INSUFFICIENT OR NO HOT WATER	
Excessive hot water consumption	<p>Electric Boosted Systems:</p> <p>Often people are surprised at the amount of hot water used, especially when showering. If the amount of hot water used during the day exceeds the storage capacity of the cylinder, it is likely that there will be insufficient hot water.</p>
	<p>Gas Boosted Systems:</p> <p>Insufficient flow may occur if multiple outlets are in use at the same time and exceed the rated flow capacity of the gas booster. If so, reduce the number of outlets in use.</p> <p>Consider discussing with your installer, fitting water saving fixtures and/or flow control or pressure limiting valves to reduce consumption.</p>
Incorrect solar system size	The system may not have been adequately sized to suit the household.
Temperature and pressure relief valve / expansion control valve discharging water continuously	<p>PTR Valves & ECV Valves (if fitted)</p> <p>It is normal and desirable that these valves allows a small quantity of water to be discharged during the heating cycle. If they discharges more than a standard bucket of water during a 24 hour period or discharges continuously there may be another problem</p> <p>If water continuously dribbles from the valve, try easing the valve gear for a few seconds as described in the section 'Maintenance and Regular Care' on page 9. This may dislodge any foreign matter and alleviate the problem.</p> <p>If the valve discharges at high flows, contact your installer or Rinnai to discuss.</p>
Booster heating not operating for electric systems	<p>Electric boosted Systems:</p> <p>Check to ensure the electric isolating switch(es) at the switchboard (usually marked "Hot water" or "water heater") is switched 'ON'.</p> <p>Check to ensure that the electric fuses for hot water at the switchboard are intact</p> <p>If running on Off-Peak, discuss boosting times with electricity supplier.</p> <p>Booster heating not operating or insufficient gas supply for gas boosted heating system</p>
Gas booster not operating or insufficient gas supply for gas boosted heating system	<p>Gas Boosted Systems:</p> <p>Check to ensure the power cord of the gas booster is plugged in and switched 'on'.</p> <p>Check gas is available and the isolation valve is opened</p> <p>Close the hot tap and wait for 10 seconds and open it again. The hot tap must be opened enough to ensure that the flow rate is sufficient for the gas booster to light.</p> <p>Check if there is gas supply to other appliances in the rest of the house</p>
Booster thermostat settings	<p>Electric Boosted Systems:</p> <p>Check the temperature of hot water delivered with a thermometer placed under the closest outlet (usually the kitchen sink) on a non-tempered hot water line</p> <p>This test should be done early in the morning after overnight electrical boosting before any hot water is used. The temperature of the water delivered should be at least 55°C (allowing for heat losses in pipe work)</p> <p>If this is not the case or the temperature may need to be increased. Contact your installer or Rinnai to discuss adjusting the thermostat.</p>
NO WATER FROM THE HOT TAP	
Restriction in the hot tap or failure of the cold water supply to the heater	Check for water flow at the other hot taps and that the cold water isolation valve is fully open

HIGH ELECTRICITY OR GAS BILL	
Hot water usage patterns	<p>Electric Boosted Systems:</p> <p>If using an off peak (overnight) boosted electrical system, the time of use of the water may affect whether heating is done by electric element or solar energy. This is because both solar heated water and electrically heated water are stored in the same cylinder. As the element is in the middle of the tank, half the tank can be heated each night by the booster element.</p> <p>If the bulk of hot water is used in the morning, there will be cold water in the cylinder for the sun to heat during the day leading to lower electricity usage.</p> <p>If the bulk of the hot water is used in the evening, the electric element will reheat the water overnight. In the morning there will only be half a cylinder of cold water for the sun to heat.</p> <p>Consider changing your usage pattern to optimise solar energy usage.</p>
High electricity cost	<p>Electric Boosted Systems:</p> <p>The electricity tariff will determine the running costs of the system. Contact the electricity supplier to confirm what these tariffs are.</p>
Temperature and pressure relief valve / expansion control valve discharging water continuously	See entry under 'Insufficient or No Hot Water'
Lack of solar gain	<p>Reduced sunlight due to overcast weather in summer or low solar contribution in winter will result in an increased dependence on electricity or gas boosting. Higher electricity or gas bills under these conditions, especially in winter, are normal.</p> <p>If the solar collectors are shaded by trees or other objects, or the glass is dirty, the effectiveness of the collectors is greatly reduced. Arrange for trimming of the trees or relocation of the solar collectors if the obstruction is permanent. Arrange for cleaning of the collector glass</p> <p>Solar collectors incorrectly positioned will also severely affect the solar gain. Check that positioning and alignment of solar collectors is in accordance with the section 'System Orientation and Inclination' on page 20.</p>
CONDENSATION IN COLLECTORS	
Condensation in solar collectors	There is a small amount of ventilation between atmosphere and the internals of the solar collector to ensure efficient operation. Under certain weather conditions, water vapour naturally present in the air may condense on the inside surface of the collector glass. This does not affect the performance of the system. If you are concerned contact Rinnai to discuss.
NOISY SOLAR COLLECTORS	
Noise from solar collectors	Occasionally on days of high solar gain, the water temperature in the collector may become very high. The noise may be similar to a boiling kettle, or an expanding contracting metallic sound. The collector is designed to withstand these conditions, and no action is needed, unless it is extreme. Contact Rinnai to discuss if you have any concerns.
WATER HAMMER	
Hot and cold water plumbing in the premises	Contact your installer or a plumber to discuss checking the clipping of hot and cold water pipe work and install a pressure limiting valve or water hammer arrestor as required

SPECIFICATIONS

GENERAL

Close Coupled hot water systems are specified according to the cylinder capacity, number of solar collectors and boost type and capacity. Boost capacity for gas boosted system depends on the gas booster model selected. Boost capacity for electrically boosted systems depends on the power rating of the electric heating element.

Specifications for the various components are shown below.

Solar flow and return connection:	Rp $\frac{3}{4}$
PTR valve connection:	Rp $\frac{3}{4}$
Cold inlet connection:	Rp $\frac{3}{4}$
Hot outlet connection:	Rp $\frac{3}{4}$
PTR valve setting	850 kPa
Rating of PTR Valve supplied	10 kW
Expansion Control Valve (ECV) setting (supplied by installer if required)	700 kPa
Max supply pressure with ECV	500 kPa
Max supply pressure without ECV	700 kPa
Pressure limiting valve rating (supplied by installer if required)	500 kPa
Electric element power rating	2.4 or 3.6 kW standard 1.8 or 4.8 kW available for stainless steel cylinders 4.8 kW available for glass lined cylinders

CYLINDER WEIGHTS

	Mass of Cylinder (empty)	Mass of Cylinder (filled)
Stainless steel 180 litre	40 kg	225 kg
Stainless steel 330 litre	80 kg	412 kg
Glass lined 200 litre	77 kg	277 kg
Glass lined 330 litre	104 kg	434 kg

SYSTEM DIMENSIONS - STAINLESS STEEL CYLINDERS

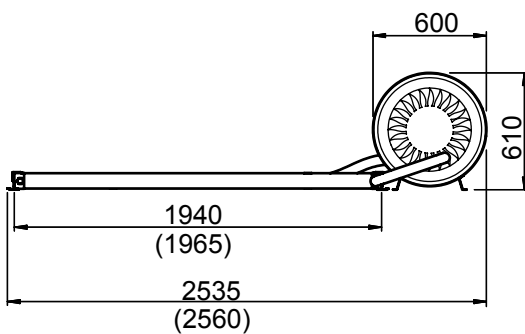
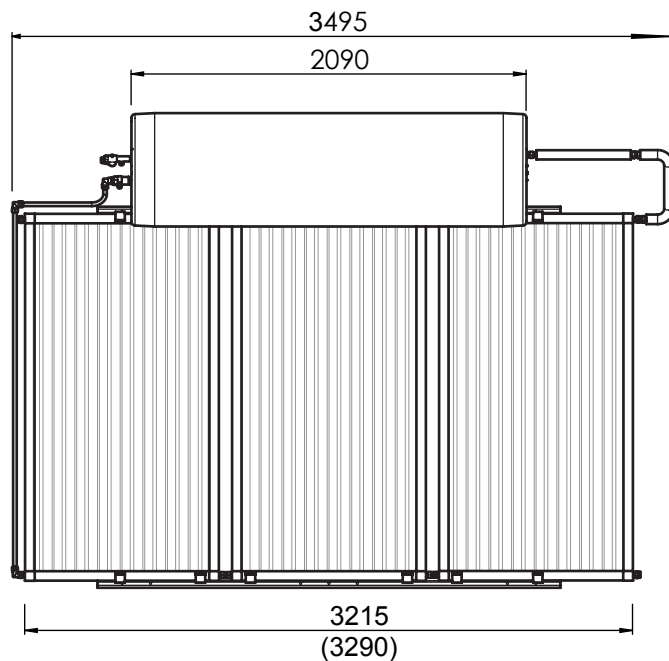
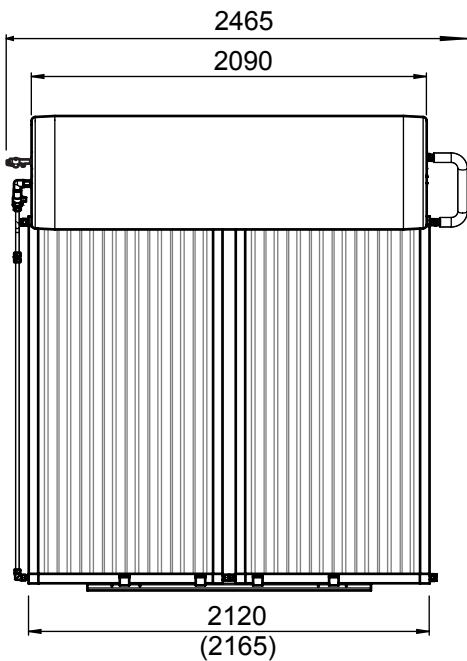
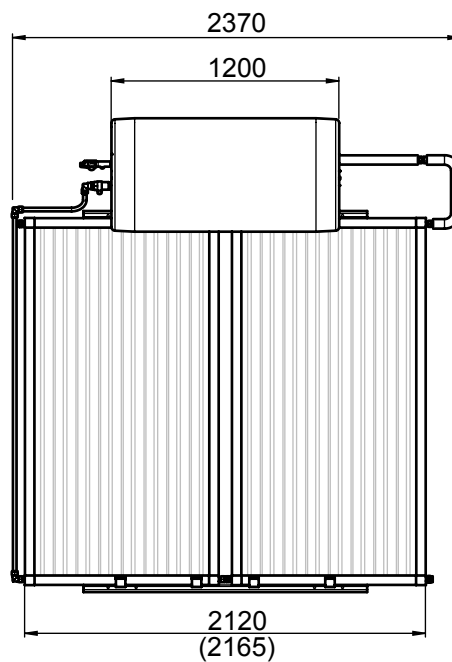
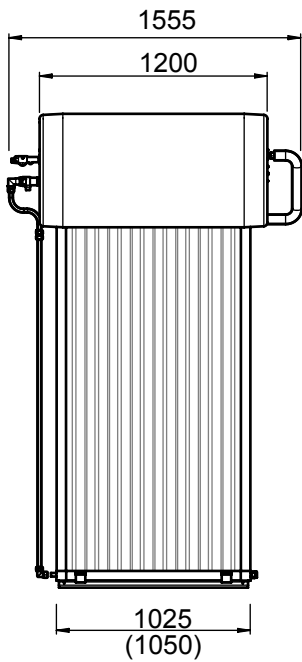

Dimensions shown for Enduro (SP200A) Collectors

Dimensions in brackets “()” for Excelsior (EXT) Collectors

SYSTEM DIMENSIONS - GLASS LINED CYLINDERS

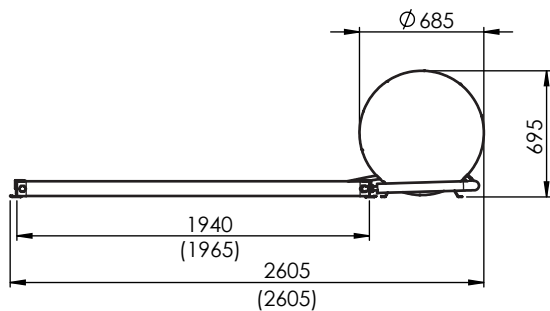
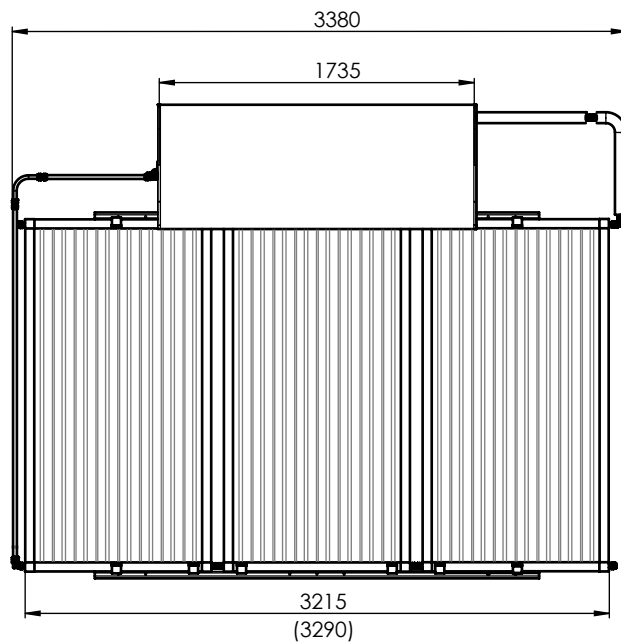
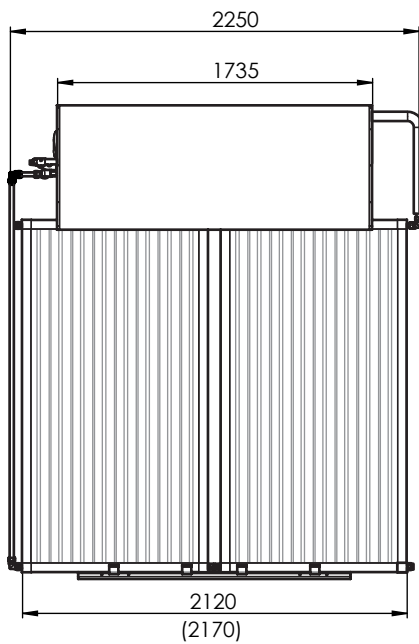
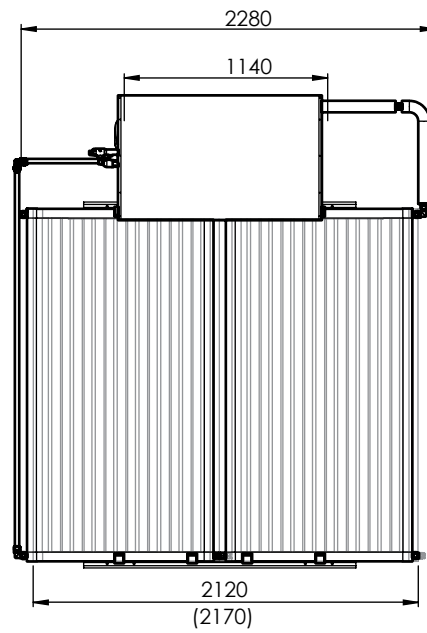
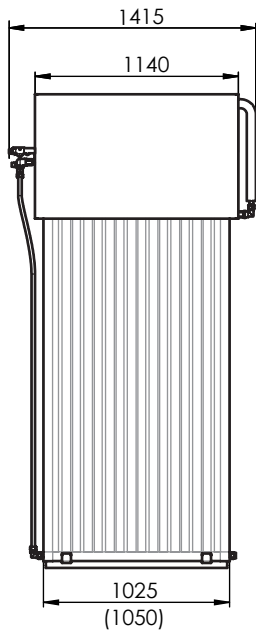

Dimensions shown for Enduro (SP200A) Collectors

Dimensions in brackets“()” for Excelsior (EXT) Collectors

SOLAR COLLECTORS

	ENDURO - SP200A	EXCELSIOR - EXT
Type	Flat plate	Flat plate
Waterways	Copper	Copper
Absorber	Aluminium	Copper
Selective Surface	High Performance	Sputtered Titanium Oxide
Maximum Operating Pressure	850 kPa	
Casing Material	Aluminium	
Overall Dimensions (L x W x H) (mm)	1940 x 1025 x 80	1964 x 1047 x 81
Weight empty (STD/FTC) (kg).	33 / 35	35 / 38
Water volume (litres)	1.3	1.5
Number risers		
Potential Solar Output at PTR relief conditions (kW)	1.25 kW	
Frost Protection	<p>The Rinnai solar hot water warranty booklet specifies the locations and conditions that apply for flat plate collectors to be warranted against frost damage.</p> <p>In locations where the warranty booklet specifies that frost valves must be used, they must be fitted for warranty to apply. If frost valves are missing you must obtain them and fit them. Failure to fit frost valves will void any warranty against frost damage.</p> <p>For full warranty terms, conditions and exclusions refer to the Rinnai warranty booklet for solar hot water. This booklet is available at www.rinnai.com.au.</p>	

SPECIFICATIONS

GAS BOOSTERS

Model Name	S20	S26	S26i *	S32 *
Boost capacity at 20°C rise (l/min)	20	26	32	37
Boost capacity at 25°C rise (l/min)	16	24	26	32
Maximum rated flow (l/min)	20	26	32	37
Minimum water supply pressure for maximum rated flow (kPa) ¹	120	200	140	180
Frost protection	Yes			
Gas consumption maximum (MJ/h)	125	188	195	250
Gas consumption minimum (MJ/h)	18	23	16	21
Hot water delivery temperature (°C) ²	70			
Dimensions - height x width x depth (mm)	530 x 350 x 194			600 x 470 x 244
Weight (kg)	15	21	21	29
<p>1 Units will operate at lower pressures but the rated flow will not be achieved.</p> <p>2 Gas boosters for Solar hot water applications must be set by Rinnai to deliver a minimum temperature of 70°C. Solar Gas boosters will be marked as Solar. Units not marked 'Solar' MUST NOT be used, and will invalidate warranty. See warranty booklet for more details.</p> <p>* These models are made to order.</p>				

INSTALLATION - ALL SYSTEMS

REGULATIONS AND OCCUPATION HEALTH AND SAFETY (OH&S)



Installation and commissioning must be performed by authorised persons.

Solar systems must be installed in accordance with these instructions and all regulatory requirements which exist in your area including those in relation to manual lifting, working at heights and on roofs. Applicable publications and regulations may include:

- AS/NZS 5601 Gas Installations
- AS/NZS 3500 National Plumbing and Drainage
- AS/NZS 3000 Wiring rules
- Building Codes of Australia (BCA)
- Local Occupational Health and Safety (OH&S) regulations

This appliance is not suitable for use as a domestic spa pool or swimming pool heater.

Solar collectors and cylinders are heavy and bulky items and are usually positioned on the roofs of buildings. Australian State and Territories have a principal Occupational Health and Safety (OH&S) Act which contains requirements relating to the handling of large, bulky or awkward items and the prevention of falls from elevated surfaces. Persons installing solar collectors must be aware of their responsibilities and be adequately trained and qualified, in accordance with local OH&S requirements.

LOCATION

System Location



These systems are only suitable for use on buildings up to 10 metres tall.

Select suitable areas of roof on which to install the solar collectors and cylinder. It is essential that the roof structure is suitable for the solar collector/cylinder combination and can support the weight of these items when full of water. It is the installers responsibility to ensure the roof can safely support the system and to visually check the roof, and if there is any damage that requires attention (such as cracked tiles etc.), to inform the owner. If this affects the safe installation of any part of the system, installation should not proceed until the damage has been rectified. Collectors should be positioned for optimum solar benefit. Refer to the section 'System Orientation and Inclination' on page 20 for more information.

All system components must be in an accessible location. Sufficient clearances shall allow access to, and removal of, all serviceable parts. Ensure the PTR valve, drain lines, thermostats and elements have sufficient clearances and are accessible for service and removal. The information on any data plates must also be readable.

All electrically boosted solar hot water heating elements must be connected to an independent, fused, AC 240V 50 Hz power supply with an isolating switch installed at the switch board.

Gas Booster Location (where applicable)

The S20, S26 and S32 gas boosters are designed for outdoor installation only. As such, they must be located in an above ground open air situation with natural ventilation, without stagnant areas, where gas leakage & products of combustion are rapidly dispersed by wind and natural convection. If an internal model which has been converted to a solar gas booster follow information supplied with the unit for location, mounting and flueing requirements.

WATER PIPES, FITTINGS AND INSULATION



The solar hot and solar cold pipes between the solar storage tank and solar collector(s) must be copper tube. Fittings used to join these pipes must use metallic materials to achieve sealing. Plastic pipe and fittings must not be used as they are not suitable for the high temperatures and pressures that may occur. Failure of plastic pipe and/or fittings can lead to the release of high temperature water and can cause severe flooding and water damage.

All hot water pipework should be insulated with sealed polyethylene foamed or equivalent insulation to optimise performance and energy efficiency, and to protect against frost damage. Such insulation may also be mandatory under local regulations.

Rinnai recommend insulation to achieve at least the R value shown in the following table.

Location of Installation	Hot pipe between tank and collectors and Pipe between tank and gas booster	Cold pipe between tank and collectors. (the side with the TA valve)
<ul style="list-style-type: none"> • CER Zone 4 • Areas defined as “B or “C” in the latest version of the Rinnai Solar Hot Water Warranty Booklet. • Any other area prone to frost conditions. 	R = 0.6 K.m ² /W	R = 0.6 K.m ² /W
<ul style="list-style-type: none"> • All other areas 	R = 0.6 K.m ² /W	insulation not required

With the exception of solar collector flow and return pipes, water pipe sizing should be performed in accordance with AS/NZS 3500.

All supplied insulation materials must be fitted as shown to minimise heat losses. In frost prone areas this insulation will also protect against frost damage. If frost valves are fitted they must remain free of any insulation materials. Frost valves must be exposed directly to ambient air conditions to ensure correct operation.

WATER SUPPLY

The maximum water pressures for the various systems are listed on page 12. Approved pressure limiting valves may be required if the ‘Maximum’ rated water supply pressures are exceeded. For gas boosted systems to achieve the rated flow through the outlet of the continuous flow water heater, the minimum water supply pressures must be supplied. The systems will operate at lower pressures but the rated flow will not be achieved.

Water chemistry and impurity limits are detailed in the separate warranty booklet. Most metropolitan water supplies fall within these requirements. If you are unsure about water quality, contact your water authority. If sludge or foreign matter is present in the water supply, a suitable filter should be incorporated in the water supply to the storage cylinder.

HOT WATER DELIVERY TEMPERATURE

Local regulations and/or the requirements of AS/NZS 3500.4 must be considered regarding the temperature limitations of hot water supplied to areas used primarily for personal hygiene. The temperature of water to these areas is limited to 45°C for early childhood centres, primary and secondary schools and nursing homes or similar facilities for young, aged, sick or people with disabilities and 50°C for all other buildings. To comply with these requirements, a temperature limiting device, such as a thermostatic mixing or tempering valve, will be required on all solar hot water systems as detailed below.

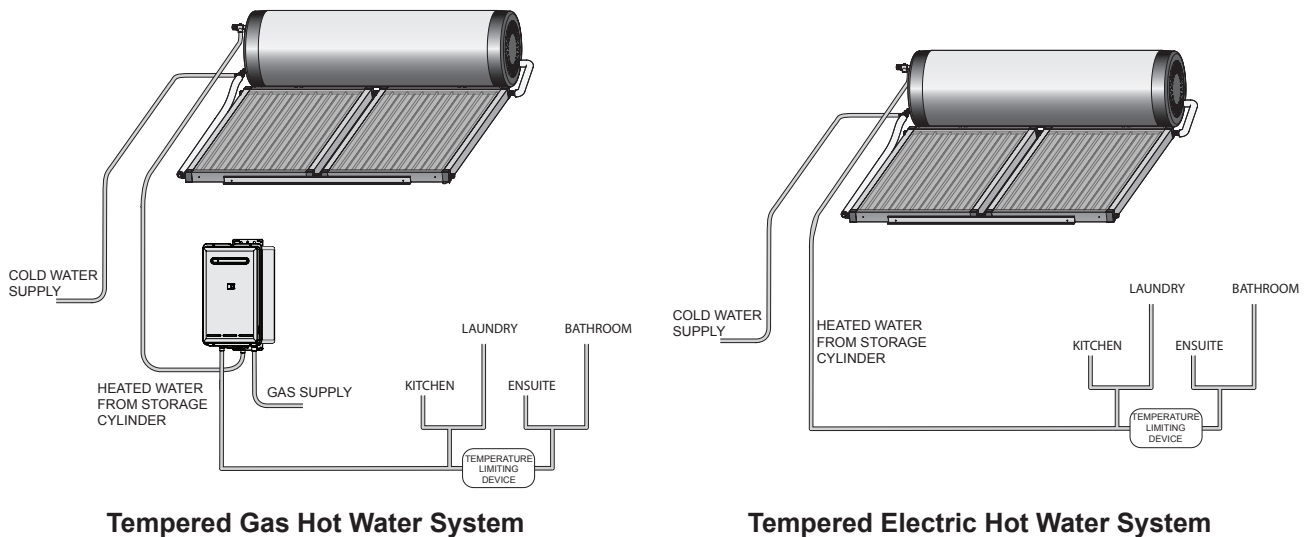

Tempered Gas Hot Water System

Tempered Electric Hot Water System

VALVES AND FITTINGS

The following valves and fittings are supplied with your solar hot water system:

- A combined pressure and temperature (PTR) relief valve, capacity 10 kW. Relief valve pressure settings vary with models. This valve is fitted at the top of the storage cylinder. The PTR valve is a safety device and it is mandatory that it is fitted by the installer in all installations.
- Thermo-Arrestor (TA) valve. This valve is fitted on the inlet pipe to the solar collectors. Its function is to control the flow of water from the tank to the collectors and stop the flow of water when the tank has reached the required temperature.
- For gas boosted systems, elbow connections for the hot, cold and gas supply are fitted at the bottom of the gas booster.
- Fittings as shown on pages 32 to 47

The following valves & fittings are to be supplied by the installer:

- A cold water expansion control valve (ECV). An ECV must be fitted in Western Australia and South Australia to the cold water supply to the storage cylinder to comply with local regulations. An ECV is recommended in all other geographical areas where the water supply has a tendency to cause scaling. This will reduce hot water discharge from the pressure and temperature relief (PTR) valve which minimises wear on this valve.
- A stop cock, non return valve and line strainer. Combination valves incorporating two or more of these functions (such as 'Trio' valves) are suitable. These are fitted to the cold water supply to the storage cylinder by the installer.
- Cold water supply and hot water discharge pipework to and from the storage cylinder.
- An isolating valve and connection union for the gas supply to the gas booster.
- An approved pressure limiting valve (supplied with some systems) is required if the maximum rated water supply pressure on page 12 is exceeded.

SYSTEM ORIENTATION AND INCLINATION

The performance of any solar hot water system is determined by the way the system is installed.

For Australian installations, solar collectors should face the equator (True North) for optimum performance. Installing solar collectors facing up to 45 degrees away from North (between North-East and North-West) will reduce efficiency by approximately 5%.

For Australian installations, the inclination of solar collectors should be the same as the latitude of the site for optimum performance. Inclinations within 20 degrees of the latitude of the site will reduce efficiency by approximately 5%. Most roofs in Australia have a slope of between 20° and 25° and provide an appropriately angled mounting surface.

Installers must ensure they comply with relevant local regulations regarding solar collector inclination and orientation.

City	Latitude	City	Latitude	City	Latitude
Adelaide	35°S	Canberra	35°S	Melbourne	38°S
Albany	35°S	Darwin	12°S	Perth	32°S
Alice Springs	24°S	Dubbo	32°S	Port Hedland	20°S
Brisbane	27°S	Geraldton	28°S	Rockhampton	24°S
Broken Hill	31°S	Hobart	42°S	Sydney	34°S
Cairns	17°S	Mildura	34°S	Townsville	19°S

Latitudes of Australian Cities

ROOF MOUNTING OPTIONS



These systems are not suitable for use on roofs over 10 m high.

For roofs with a slope of 10° or less a flat roof frame must be used.

Rinnai do not recommend installing Close Coupled systems on roofs with a pitch greater than 30°. An additional strap should be used to prevent the cylinder from tipping over if a system is installed in this manner. Refer page 29.

It is normal to mount the solar collectors down close to the gutter. Roof construction must be checked to ensure that the roof timbers are capable of supporting the additional load. (Refer to AS 3500.4 Appendix H).

For tiled roof installations. Check for cracked or damaged tiles in the area of proposed installation. Replace any faulty tiles. If spare tiles are not available, swap damaged tiles with good ones from along the gutter line.

Standard Installation

Installation details are in this manual.

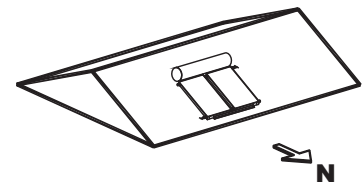

Flat Roof Frame

Additional information is provided in the roof frame manual provided with the frame.

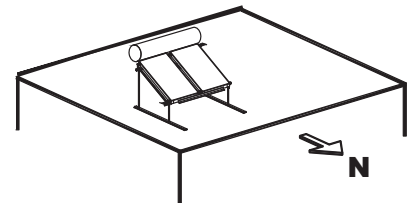

Reverse Pitch Frame

Additional information is provided in the roof frame manual provided with the frame.

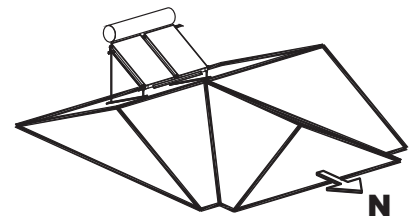

Side Pitch Frame

Additional information is provided in the roof frame manual provided with the frame.

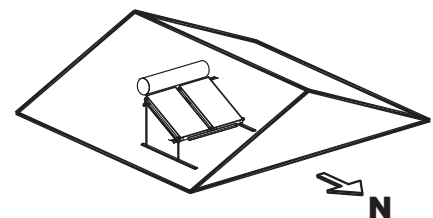

Cyclone Frame

Additional Information is provided in the Cyclone frame manual provided with the cyclone frame

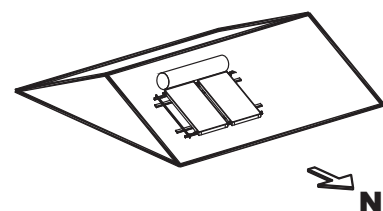

Mounting Location Suitability

The following table indicates which installation locations are suitable for different roof mounting options for Rinnai close coupled solar hot water systems.

Wind Region	Region A			Region B			Region C		Region D
Roof Area (see page 23 for explanation)	Area 1	Area 2	Area 3	Area 1	Area 2	Area 3	Area 1	Areas 2 & 3	Areas 1,2 & 3
Pitched roof	✓	✓	✓	✓	✓	✗	✗	✗	✗
Cyclone frame	✓	✓	✓	✓	✓	✗	✓*	✗	✗
Flat roof frame	✓	✓	✗	✓	✗	✗	✗	✗	✗
Reverse or side pitch frame	✓	✗	✗	✗	✗	✗	✗	✗	✗

* Enduro (SP200A) collectors only. Only systems defined in the Cyclone Frame Installation Manual.

✓ Suitable

✗ Not Suitable

Wind Region

Australia has been categorised into 4 wind regions. Each region has varying wind load parameters such as wind speed and wind direction multipliers. The diagram below illustrates the region locations. For more information on how to classify site specific wind loading parameters see AS/NZS 1170.2 - Wind Actions, or consult a certified structural engineer.

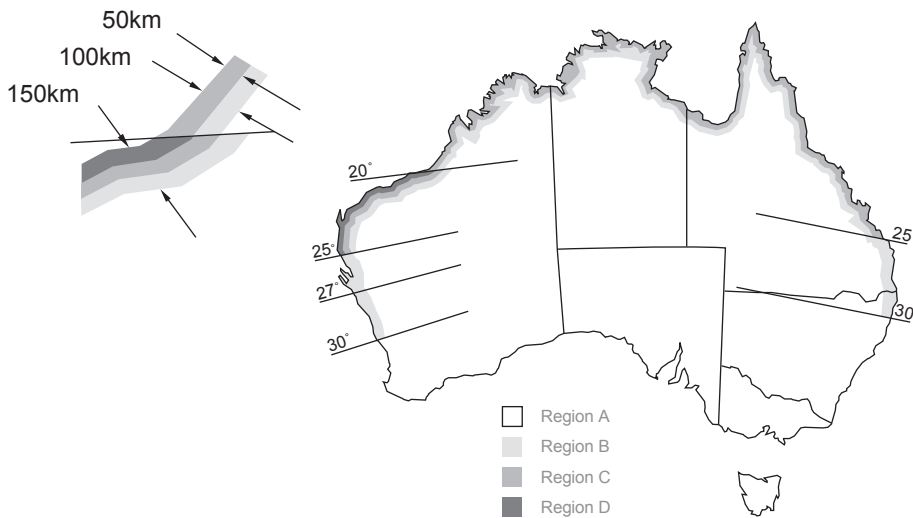

Region A	Region B		Region C		Region D
Callytharra Springs	Adelaide River	Ivanhoe	Borroloola	Mackay	Carnarvon
Gascoyne Junction	Atherton	Kyogle	Broome	Mareeba	Exmouth
Green Head	Biloela	Marble Bar	Bundaberg	Millstream	Karratha
Kununurra	Brisbane	Mullewa	Burketown	Moreton	Onslow
Lord Howe Island	Christmas Island	Norfolk Island	Cairns	Nhulunbuy	Port Hedland
Morawa	Collinsville	Torres Strait Islands	Cocos Islands	Normanton	
Toowoomba	Corindi	Wyndham	Darwin	Rockhampton	
Wittanoom	Geraldton		Derby	Townsville	
Bourke			Karumba		

Indicative selection of towns in Regions A,B,C &D

Roof Area

As per AS/NZS 1170.2, domestic pitched and flat roof areas are classified into working areas. The diagram below illustrate these areas.

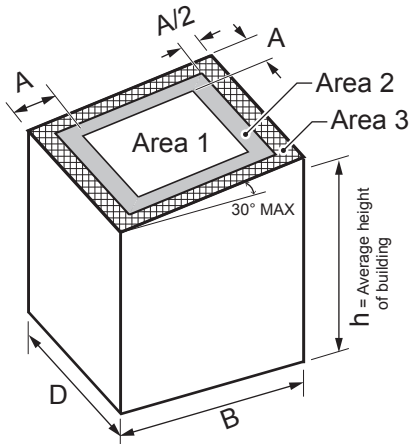

A = minimum of 0.2 x B, 0.2 x D and 1 x h

Area 1 - Internal of roof.

Area 2 - Intermediate area, wind pressures increased by 1.5 times.

Area 3 - Roof edge including corners, wind pressures increased by 3 times. For installations in roof area 3, a minimum of 0.5m from the edge of the roof is recommended.

Height limit for all installations is 10 metres.

For more information on how to classify specific roof area installations, or for building heights exceeding 10 metres see AS/NZS1170.2 or consult a certified structural engineer.

Some examples are shown below.

Example 1

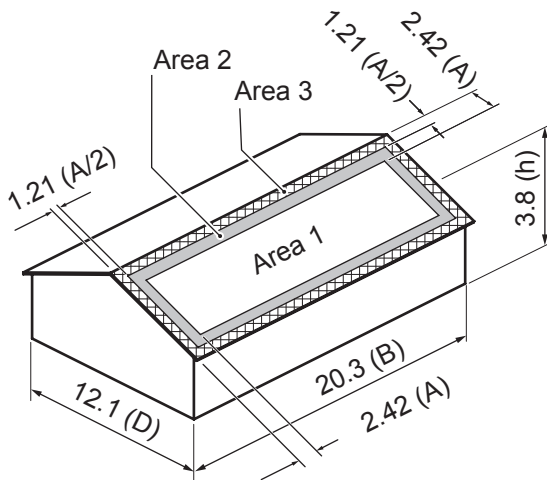

Example 2

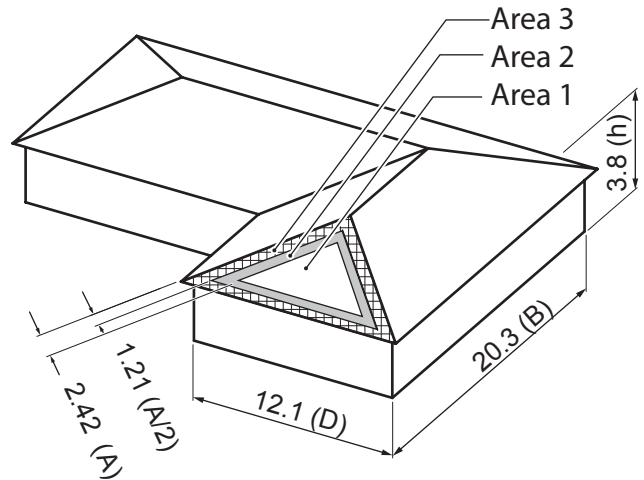

In both examples :

A = min of $0.2 \times 20.3 = 4.06$
 $0.2 \times 12.1 = 2.42$
 $1 \times 3.8 = 3.8$

→ A = 2.42

A/2 = 1.21 m

STANDARD INSTALLATION



This type of installation is not suitable for use on roofs over 10 m high.

This type of installation is not suitable for use in cyclonic areas.

Collector Rail Pre Assembly

Assemble the collector rail components as shown. Only loosely attach the collector retainers to the rails. Details of component quantities are shown in the tables on page 32 to 47.

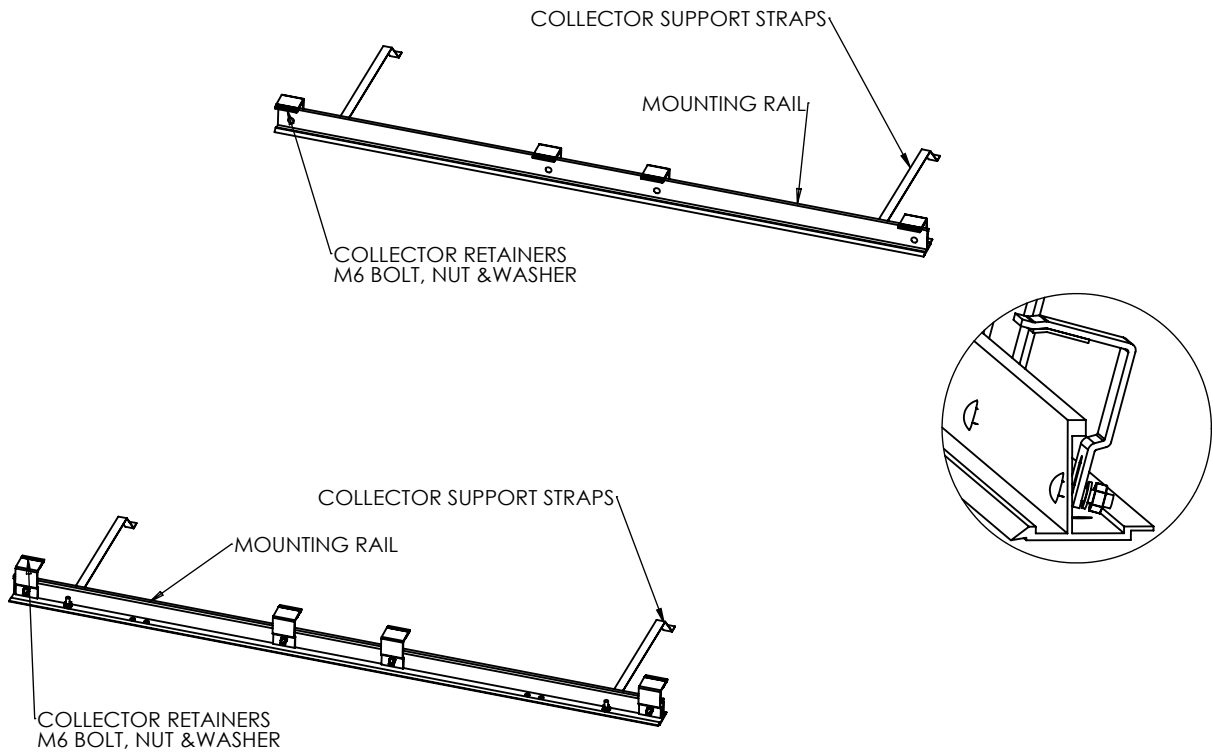

Fastening Collectors to a Tiled Roof



This type of installation is not suitable for use on roofs over 10 m high.

This type of installation is not suitable for use in cyclonic areas.

Attach the collector mounting straps to the rafter or truss under the tiles.

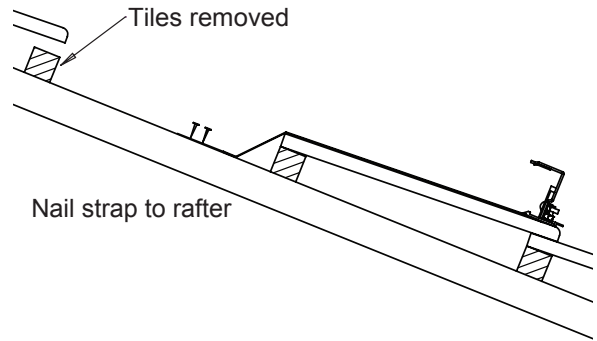

Place the collector(s) onto the roof above the lower rail. If more than one collector is being installed then join them together using the compression fittings supplied.

Push down on the collector retainers to clamp the collector and tighten the nuts.

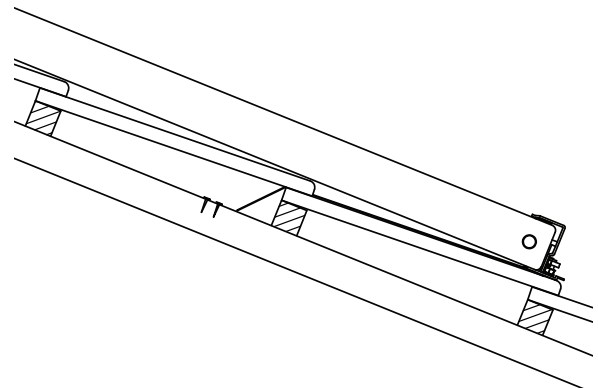

Position the upper collector rail above the collectors. Push down on the retainers to clamp the collector and tighten the nuts.

Attach the collector mounting straps to the rafter or truss under the tiles.

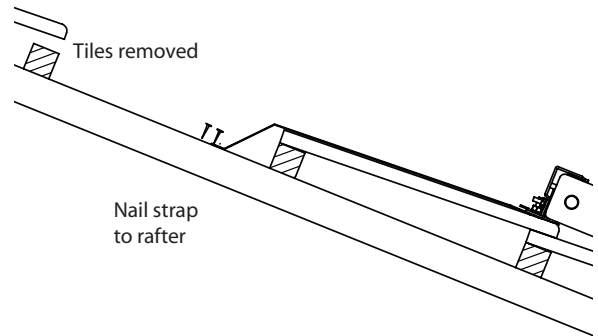

Replace the tiles and ensure the collector is secure.

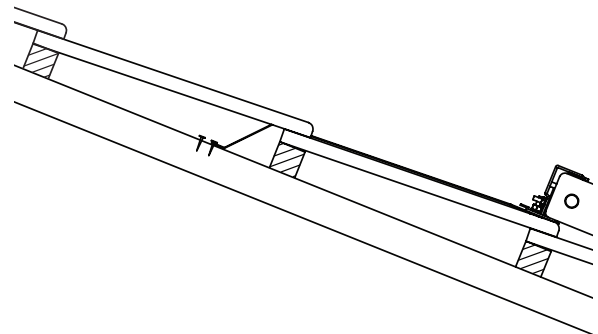

Fastening Collectors to a Metal Roof



This type of installation is not suitable for use on roofs over 10 m high.

This type of installation is not suitable for use in cyclonic areas.

Position the lower collector mounting rail assembly so that the rail is over the roof purlin.

Drill through the roof iron and purlin using the holes in the rail as a guide. Apply some silicone sealant down the holes to ensure no water leakage.

Bolt the rail to the roof purlin using a suitable fastener.

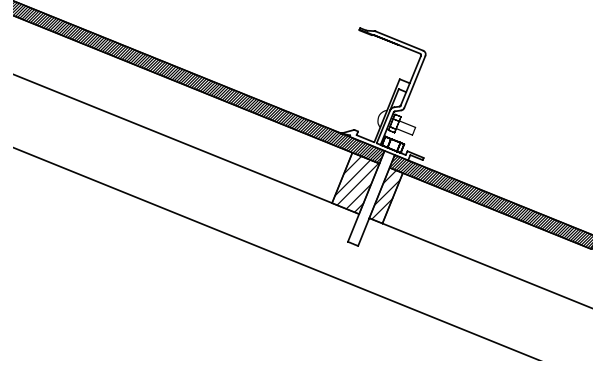

Position the collector(s) onto the roof above the lower rail. If more than one collector is being installed, join them together using the compression fittings supplied.

Push down on the collector retainers to clamp the collector and tighten the nuts.

Place the upper collector mounting rail above the collectors. Push down on the collector retainers to clamp the collector and tighten the nuts.

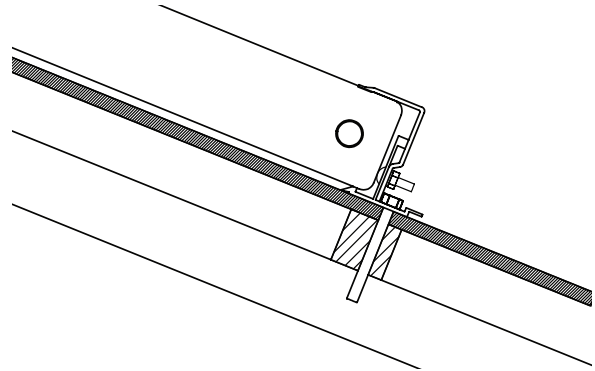

Drill through the roof iron and purlin using the upper mounting rail as a guide. Apply some silicone sealant down the holes to ensure no water leakage and secure with suitable fasteners.

Alternatively the rail can be attached to the roof using the collector mounting straps.

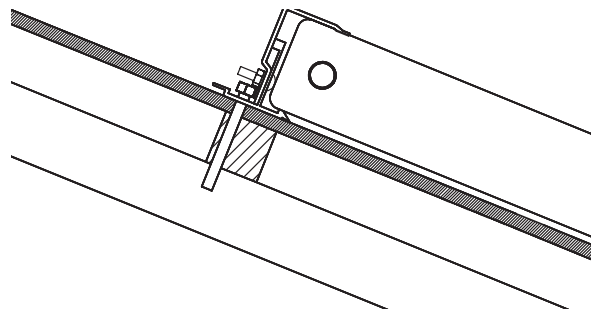

Attaching mounting rail to cylinder on stainless steel cylinders

Depending on the packaging, either one or two rails are attached to the cylinder.

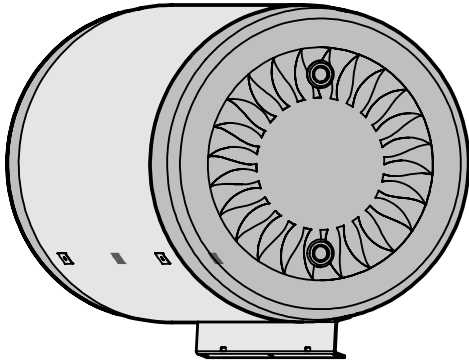

The extra rail and fastenings are packed with the cylinder. They are screwed into the rail mounting holes in the cylinder.

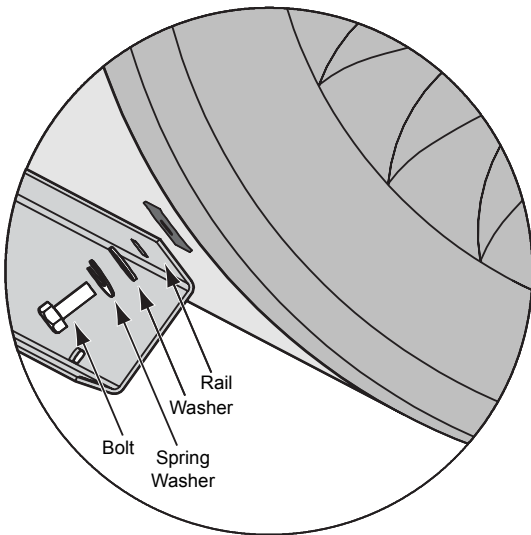

Attach the rail using the bolts, washers and spring washers in the order shown.

Ensure the feet on the rails face outwards

Ensure that the bolt is tightened sufficiently to flatten the spring washer. This ensures that the bolt is adequately tightened.

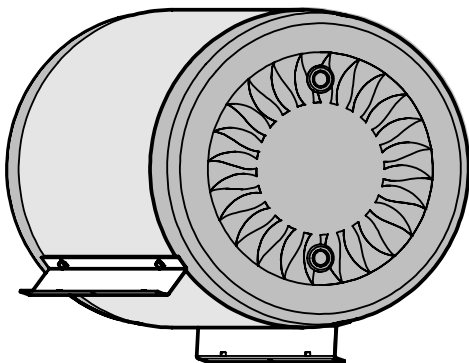

Once the rail is attached and suitably tightened, continue the cylinder installation as shown on the next page.

Fastening Cylinder to Roof

Lift the storage cylinder onto the roof and locate it above the collector bank. The cylinder's position should be as central as possible to the collector bank. The lower rail must be on a load bearing surface.

Slide the cylinder support strap into the slots located in the uppermost cylinder support bracket so that the strap is in line with a suitable fastening position

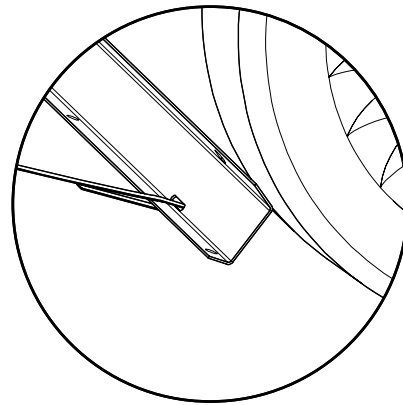

Tiled Roof

Remove tiles one row up from the storage cylinder. Apply tension to the straps and attach them to the rafters using a suitable fastener.

Replace the tiles

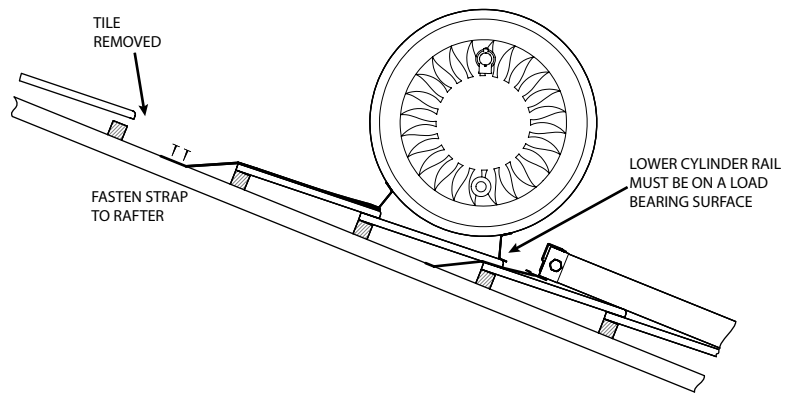

Metal Roof

Bolt the lower support rail to the roof using a suitable fastener.

Apply tension to the cylinder support straps and attach them to the rafters using a suitable fastener.

Seal any holes in roof using a suitable sealant to ensure roof is water tight.

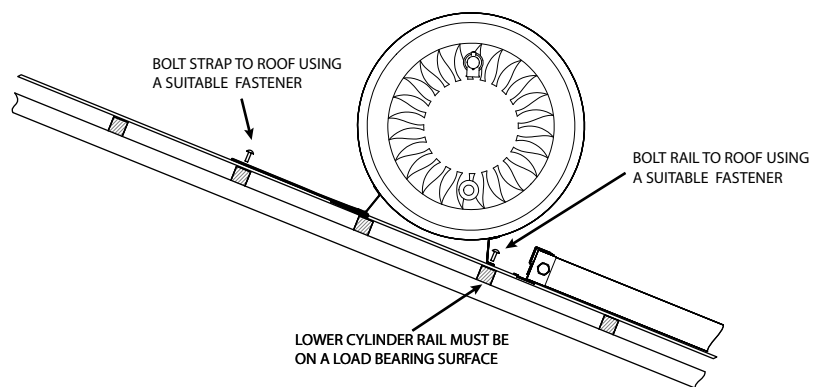

ROOF PITCH GREATER THAN 30°

In situations where a Close Coupled System is installed onto a roof with a pitch of 30° or greater, an additional strap must be used to prevent the cylinder tipping over. Builders strapping available from hardware stores is suitable for this. The strapping is attached through the slots in the front cylinder rail, goes over the tank and is then fastened to the roof behind the cylinder.

Tiled Roof

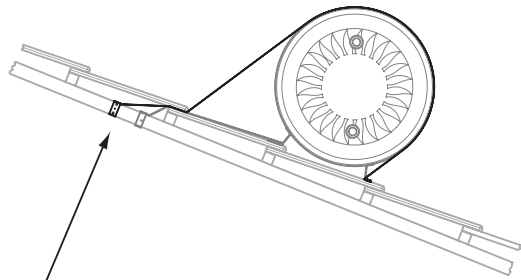

Securely fasten strap to roof using a suitable fastener

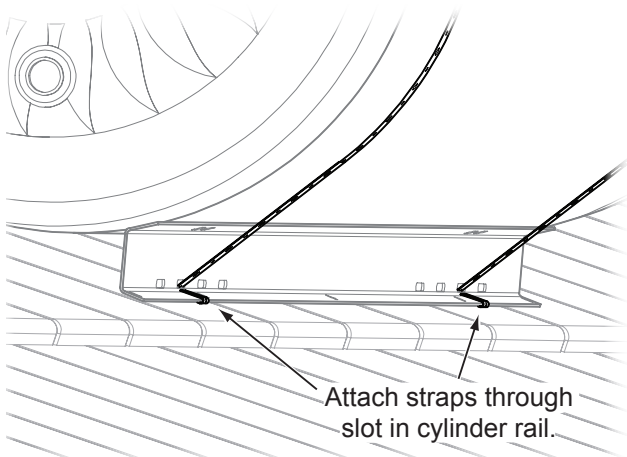

Attach straps through slot in cylinder rail.

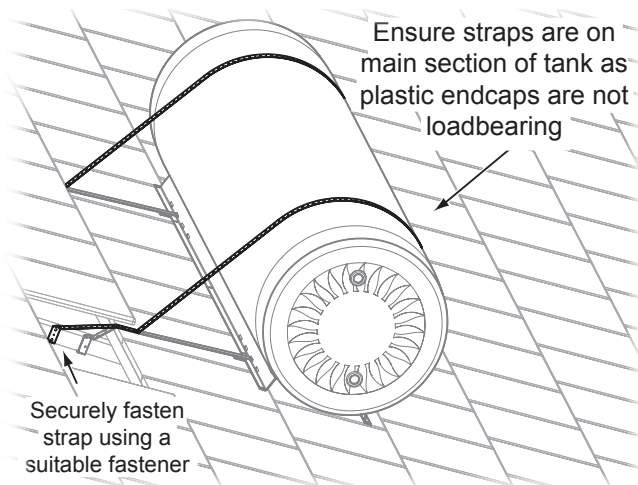

Ensure straps are on main section of tank as plastic endcaps are not loadbearing

Securely fasten strap using a suitable fastener

Metal Roof

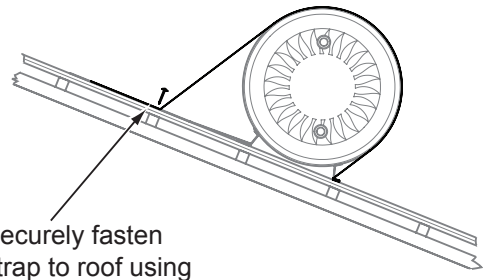

Securely fasten strap to roof using a suitable fastener

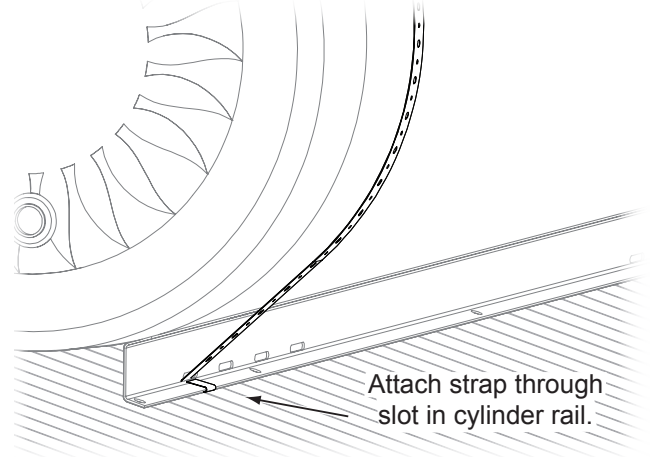

Attach strap through slot in cylinder rail.

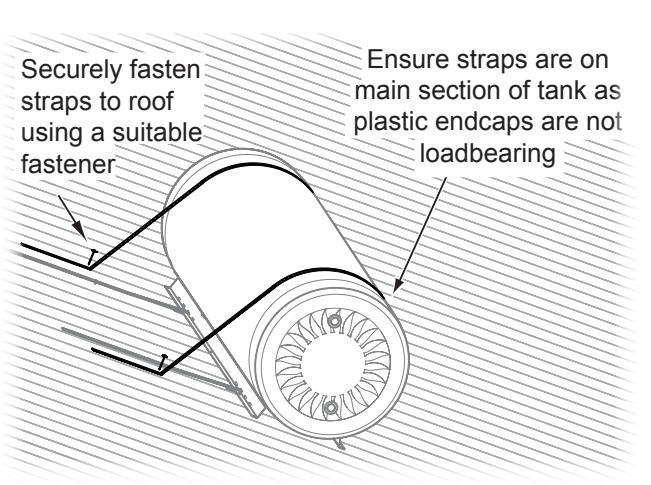

Securely fasten straps to roof using a suitable fastener

Ensure straps are on main section of tank as plastic endcaps are not loadbearing

FRAMED INSTALLATIONS - FLAT, REVERSE AND SIDE PITCH



This type of installation is not suitable for use on roofs over 10 m high.

This type of installation is not suitable for use in cyclonic areas.

Flat Roof Frame

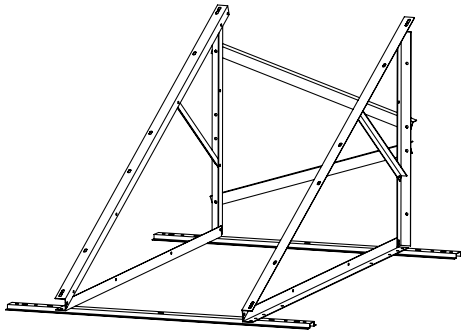

For use on a flat roof or where the roof pitch is too low.

This frame allows the system to be installed at a suitable inclination.

Installations instructions are provided in the Rinnai Frame Installation Manual.

A Glass Lined 330 litre tank with 3 collectors CANNOT be installed on a flat roof frame

Reverse Pitch Frame

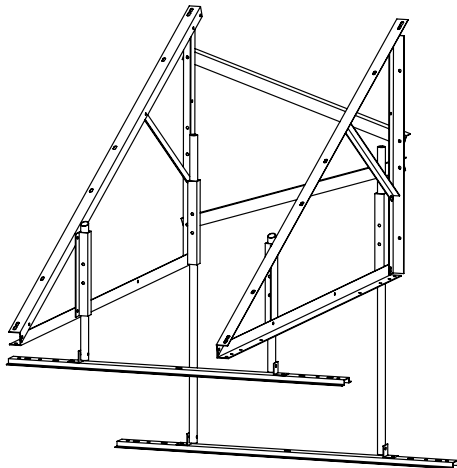

These comprise of a Close Coupled system flat roof frame and a side/reverse pitch kit.

They can be used when the system need to be installed in the reverse direction to the direction the roof is facing.

For example, using a reverse pitch frame on a South facing roof enables the system to be oriented to the North.

Installations instructions are provided in the Rinnai Frame Installation Manual.

A 330 litre tank with 3 collectors CANNOT be installed on a reverse pitch roof frame

Side Pitch Frame

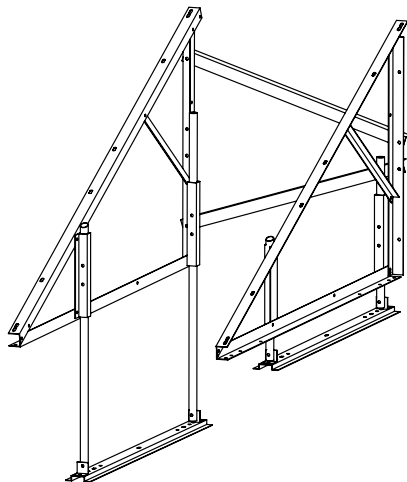

These comprise of a Close Coupled system flat roof frame and a side/reverse pitch kit.

They can be used when the system need to be installed side on to the direction the roof is facing.

For example, using a side pitch frame on an East or West facing roof enables the system to be oriented to the North.

Installations instructions are provided in the Rinnai Frame Installation Manual.

A 330 litre tank with 3 collectors CANNOT be installed on a side pitch roof frame

FRAMED INSTALLATIONS - CYCLONE FRAME

Assemble cyclone frame and mount components as described in instructions provide with cyclone frame kit.

Mounting Collector Rail and Cylinder to Frame

Attach the lower mounting rail (provided in the installation kit) to the frame, using the nuts bolts and washers provided in the frame kit.

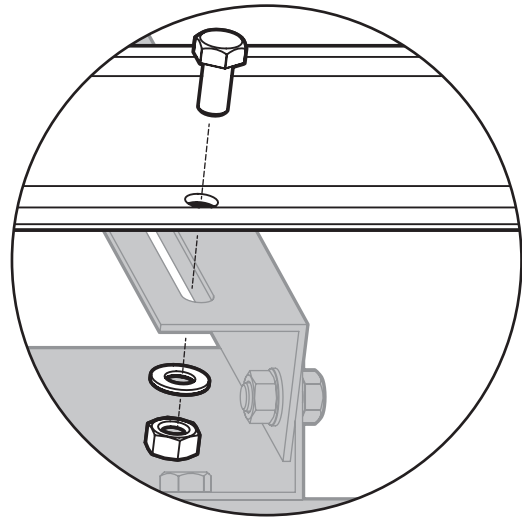

Position the collector(s) on the lower rail

For installations with 2 or 3 collectors, join the collectors using the compression unions provided in the installation kit.

Fasten the collector(s) to the rails using the collector retainers



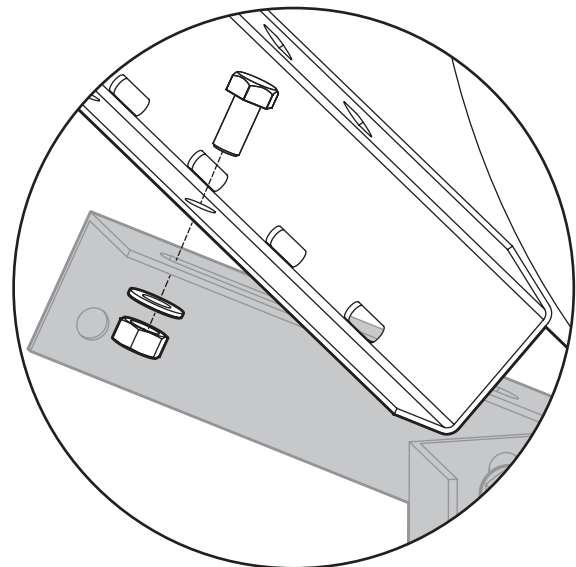



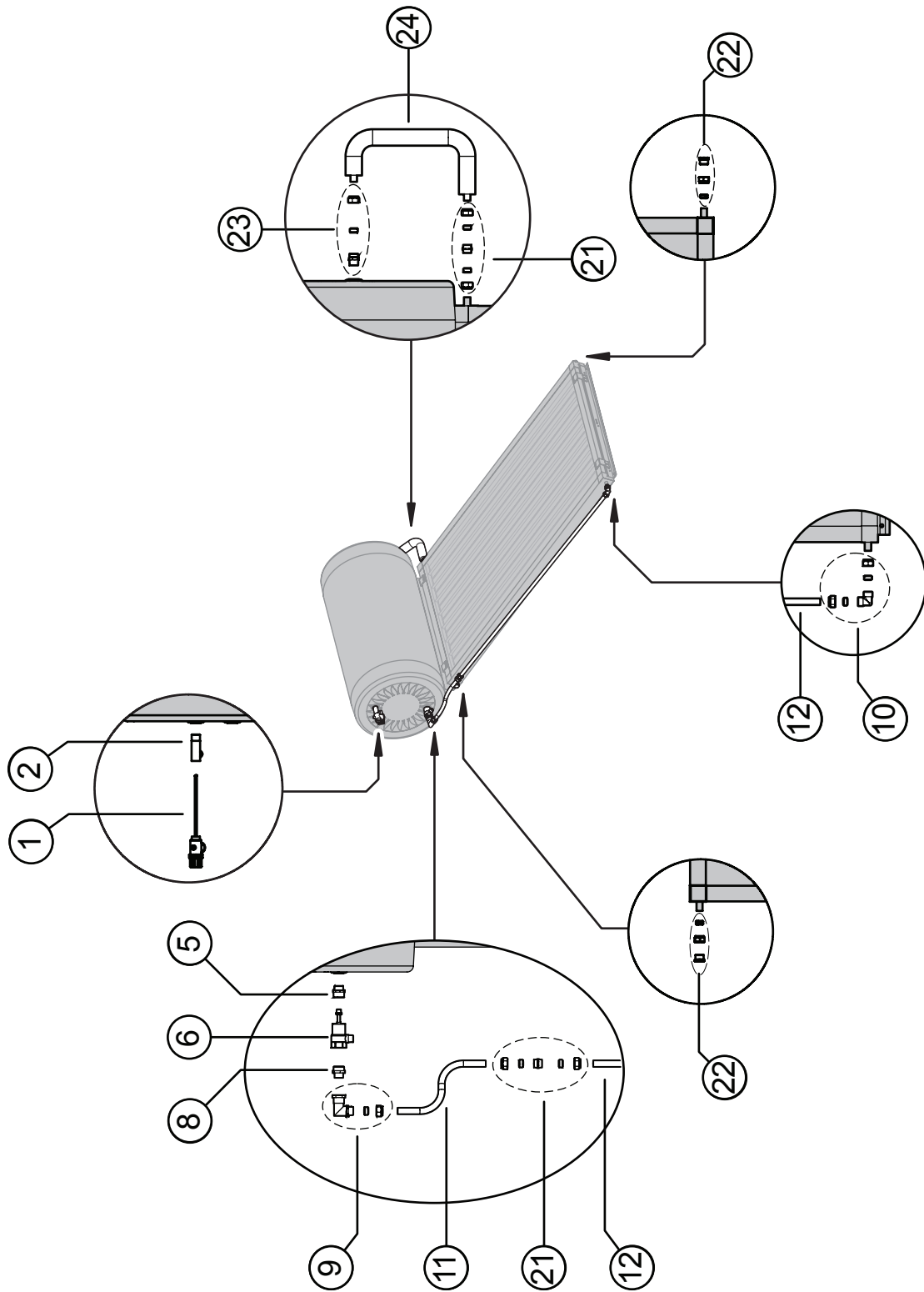



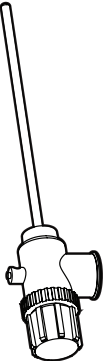
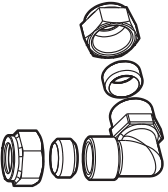
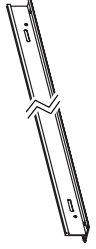
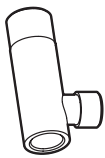
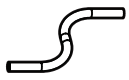
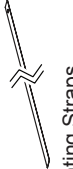

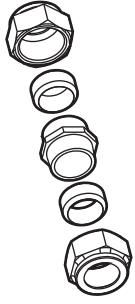

Position the cylinder above the collector(s) and fasten both cylinder rails to the frame using the nuts, bolts and washers provided in the frame kit.

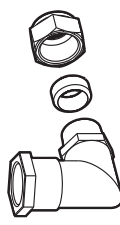

180 LITRE STAINLESS STEEL CYLINDER WITH 1 COLLECTOR - IKS180CCT01C









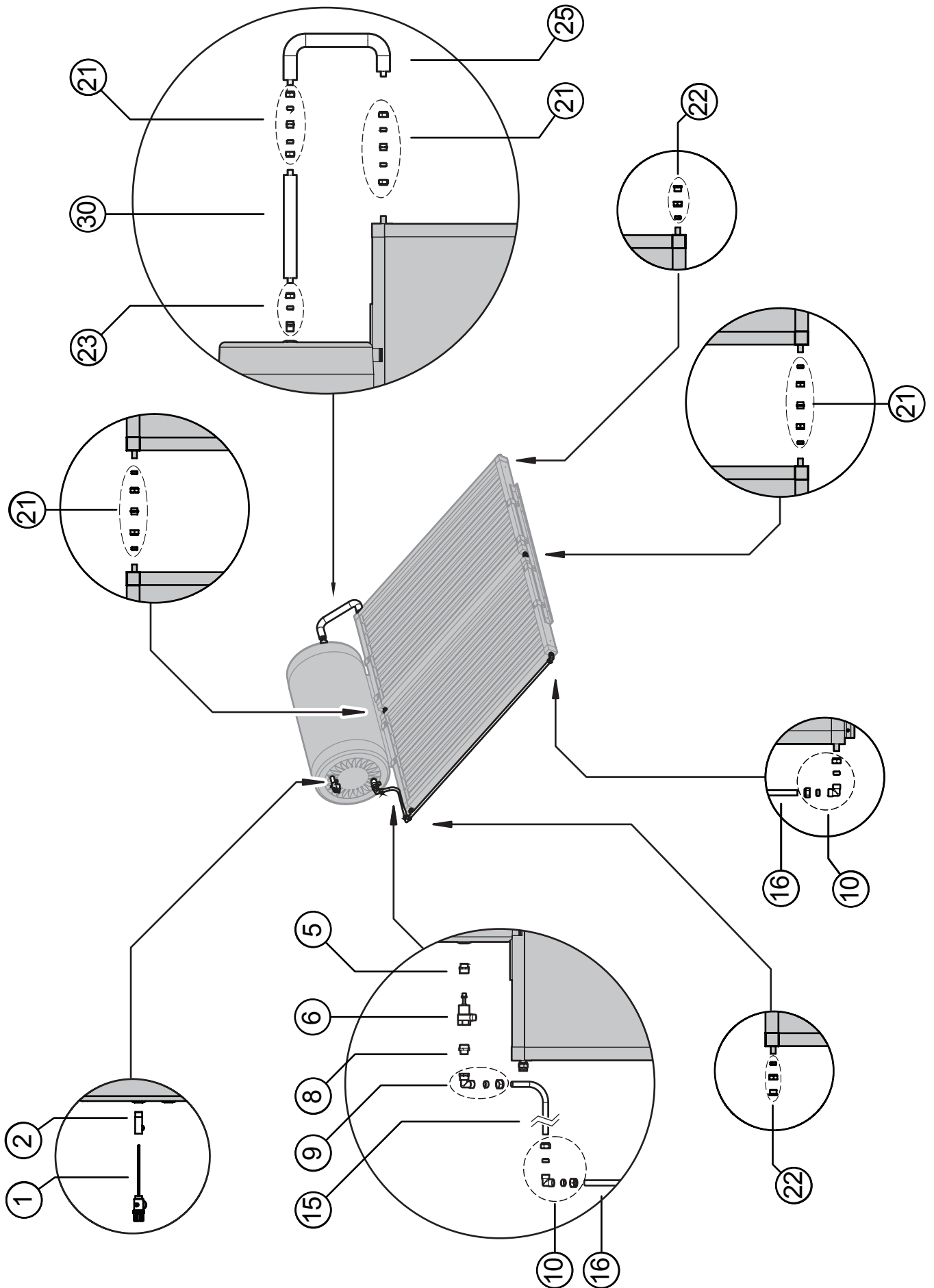



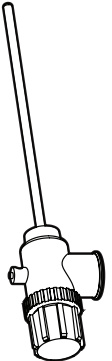

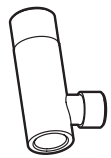
180 LITRE STAINLESS STEEL CYLINDER WITH 1 COLLECTOR - IKS180CCT01C

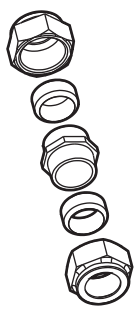
Qty	Item / Part Number	Qty	Item / Part Number	Qty	Item / Part Number
1	 P&TR Valve *supplied with cylinder 11004784	1	 Elbow assembly - 1 x Elbow G 3/4 (Kinco) x G 3/4 (Kinco) - 2 x Kinco nuts and olives 3/4 21201038	-	 Mounting Rail Small 14201196
2	 T adaptor hot outlet *supplied with cylinder 19001018	1	 Copper Pipe 31601772	-	 Collector Mounting Straps 2 with collector, 2 in kit 12401012
5	 Reducing Nipple R1 x R 3/4 17201036	1	 Copper Pipe 1765mm 31601775	-	 Cylinder Mounting Straps 12401013
6	 TA Valve 11007711	2	 Union Compression 3/4 - 1 nipple G 3/4 - 2 x Kinco nuts and olives 3/4 32201709	-	 M8 Bolt Washer and Nut (used to bolt collector mounting strap to mounting rail) Bolt 22601052 Washer 17401072 Nut 16801062
8	 Adaptor M33 x R 3/4 16601096	2	 Stop end assembly 28801025	-	 Collector Retainer 26601706
9	 Elbow assembly Rp 3/4 x G 3/4 (Kinco) Elbow 21201026 Kinco Nut 16801018 Kinco Olive 33001011	1	 Union 3/4-compression to R - 1 x nipple G 3/4 x R 3/4 - 1 x Kinco nut and olive 3/4 32201713	-	 M6 Bolt Washer and Nut (used with collector retainers) Bolt 22601073 Washer 17401073 Nut 16801007
		1	 Copper Pipe with Insulation 31601750	-	 Operation and Installation Manual 15401022
		1		-	 Warranty Booklet 15401041
				-	 STC form 15401023

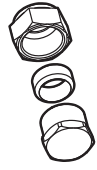
180 LITRE STAINLESS STEEL CYLINDER WITH 2 COLLECTORS - IKSUNICCT23C

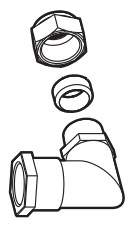

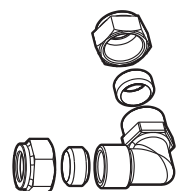





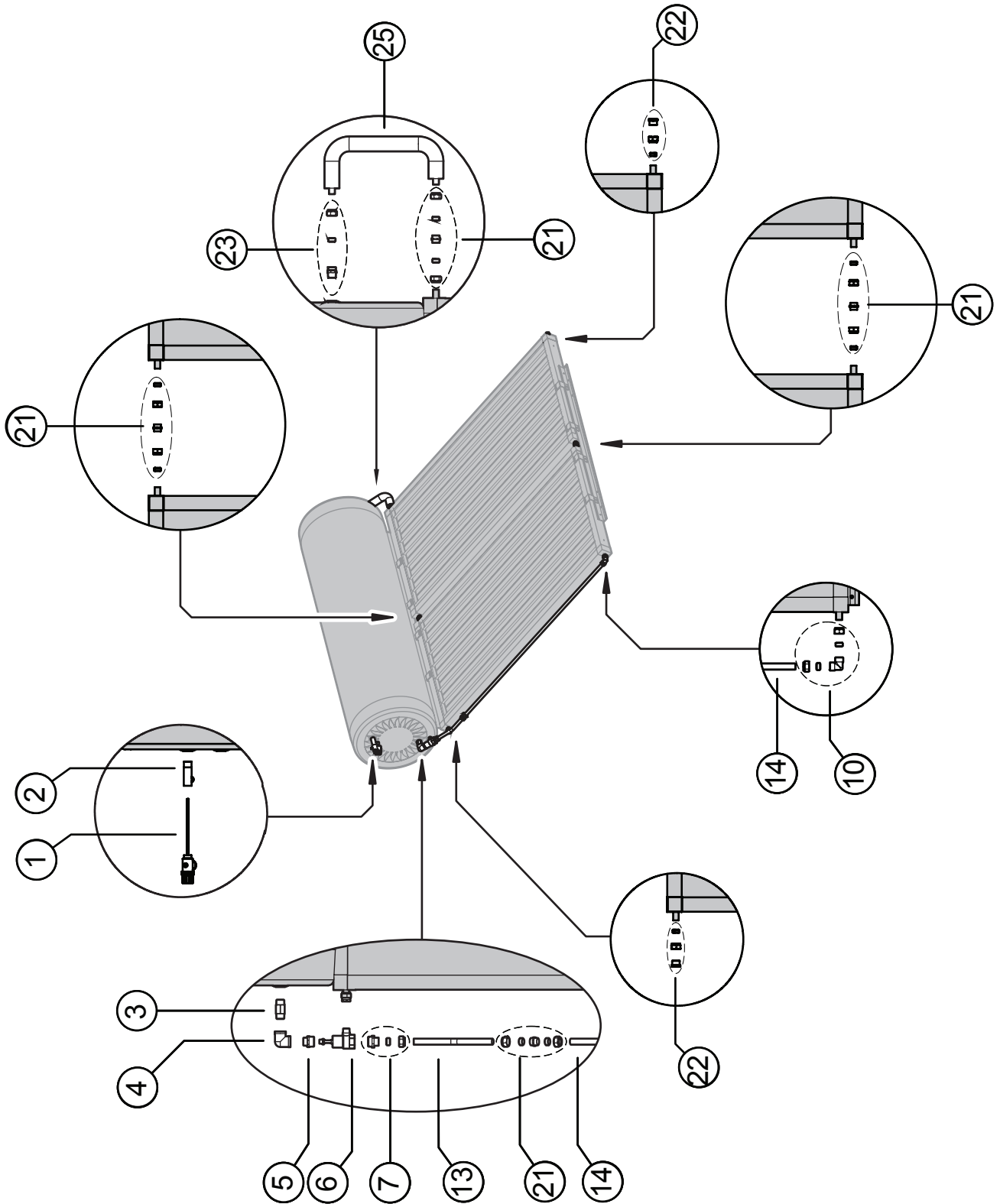



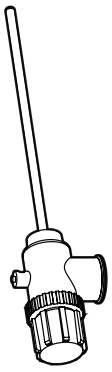
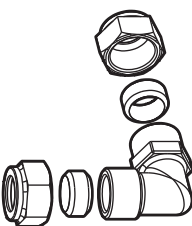

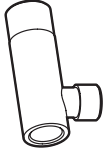

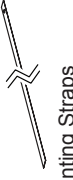







180 LITRE STAINLESS STEEL CYLINDER WITH 2 COLLECTORS - IKSUNICCT23C

Qty	Item / Part Number	Qty	Item / Part Number	Qty	Item / Part Number
1	 P&TR Valve *supplied with cylinder 11004784	1	 Copper Pipe (490 long - installer to cut to approx 375) 31601774	-	Mounting Rail Medium 14201197
2	 T adaptor hot outlet *supplied with cylinder 19001018	1	 Copper Pipe 1945mm (1945 long - installer to cut to approx 1915) 31601778	2 2 not used	Mounting Rail Large 14201198
1	 Reducing Nipple R1 x R 3/4 17201036	6 2 not used	 Union Compression 3/4 - 1 nipple G 3/4 - 2 x Kinco nuts and olives 3/4 32201709	-	Collector Mounting Straps supplied with collectors 12401012
1	 TA Valve 11007711	2	 Stop end assembly 28801025	-	Cylinder Mounting Straps 12401013
1	 Adaptor M33 x R 3/4 16601096	1	 Union 3/4-compression to R - 1 x nipple G 3/4 x R 3/4 - 1 x Kinco nut and olive 3/4 32201713	4	M8 Bolt Washer and Nut (used to bolt collector mounting strap to mounting rail) Bolt 22601052 Washer 17401072 Nut 16801062
1	 Elbow assembly Rp 3/4 x G 3/4 (Kinco) Elbow 21201026 Kinco Nut 16801018 Kinco Olive 3001011	1	 Copper Pipe with Insulation 31601751	12 4 not used	Collector Retainer 26601706
2	 Elbow assembly - 1 x Elbow G 3/4 (Kinco) x G 3/4 (Kinco) - 2 x Kinco nuts and olives 3/4 21201038	1	 Copper Pipe with Insulation (540 long - installer to cut to approx 437) 31601753	12 4 not used	M6 Bolt Washer and Nut (used with collector retainers) Bolt 22601073 Washer 17401073 Nut 16801007
			 Collector Joining Insulation - 3 x insulation, 3 x foil tape (1 of each not used) 33202053	1	Operation and Installation Manual 15401022
				1	Warranty Booklet 15401041
				1	STC form 15401023

330 LITRE STAINLESS STEEL CYLINDER WITH 2 COLLECTORS - IKS330CCT02C









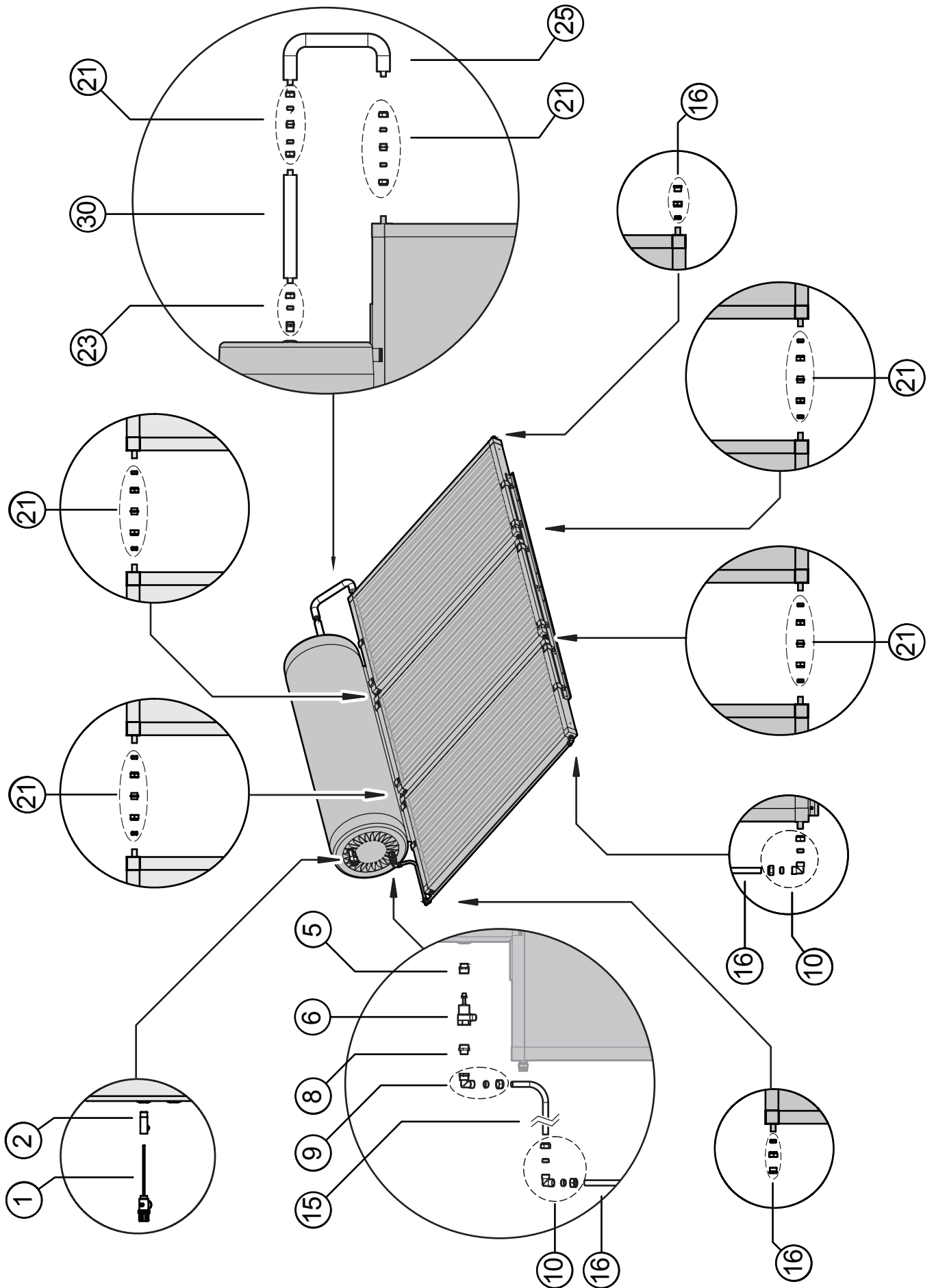



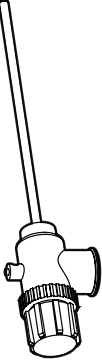







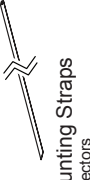

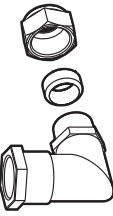

330 LITRE STAINLESS STEEL CYLINDER WITH 2 COLLECTORS - IKS330CCT02C

Qty	Item / Part Number	Qty	Item / Part Number	Qty	Item / Part Number
1	 P&TR Valve *supplied with cylinder 11004784	1	 Elbow assembly - 1 x Elbow G 3/4 (Kinco) x G 3/4 (Kinco) - 2 x Kinco nuts and olives 3/4 21201038	1	 Mounting Rail Medium 14201197
2	 T adaptor hot outlet *supplied with cylinder 19001018	1	 Copper Pipe 31601773	4	 Collector Mounting Straps *supplied with collectors 12401012
3	 R3/4 Nipple (long) 17201011	1	 Copper Pipe 1652mm 31601777	2	 Cylinder Mounting Straps 12401013
4	 Elbow Rp 3/4 x Rp 3/4 21201004	4	 Union Compression 3/4 - 1 nipple G 3/4 - 2 x Kinco nuts and olives 3/4 32201709	4	 M8 Bolt Washer and Nut (used to bolt collector mounting strap to mounting rail) Bolt 22601052 Washer 17401072 Nut 16801062
5	 Reducing Nipple R1 x R 3/4 17201036	2	 Stop end assembly 28801025	8	 Collector Retainer 26601706
6	 TA Valve 11007711	1	 Union 3/4 -compression to R - 1 x nipple G 3/4 x R 3/4 - 1 x Kinco nut and olive 3/4 32201713	8	 M6 Bolt Washer and Nut (used with collector retainers) Bolt 22601073 Washer 17401073
7	 Adaptor Assembly M33 x G 3/4 (Kinco) Nipple 16601067 Nut 16801018 Olive 33001011	1	 Copper Pipe with Insulation 31601751	1	 Operation and Installation Manual 15401022
		-	 Collector Joining Insulation - 2 x insulation, 2 x foil tape 33202052	1	 Warranty Booklet 15401041
				1	 STC form 15401023

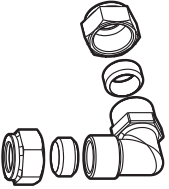
330 LITRE STAINLESS STEEL CYLINDER WITH 3 COLLECTORS - IKSUNICCT23C









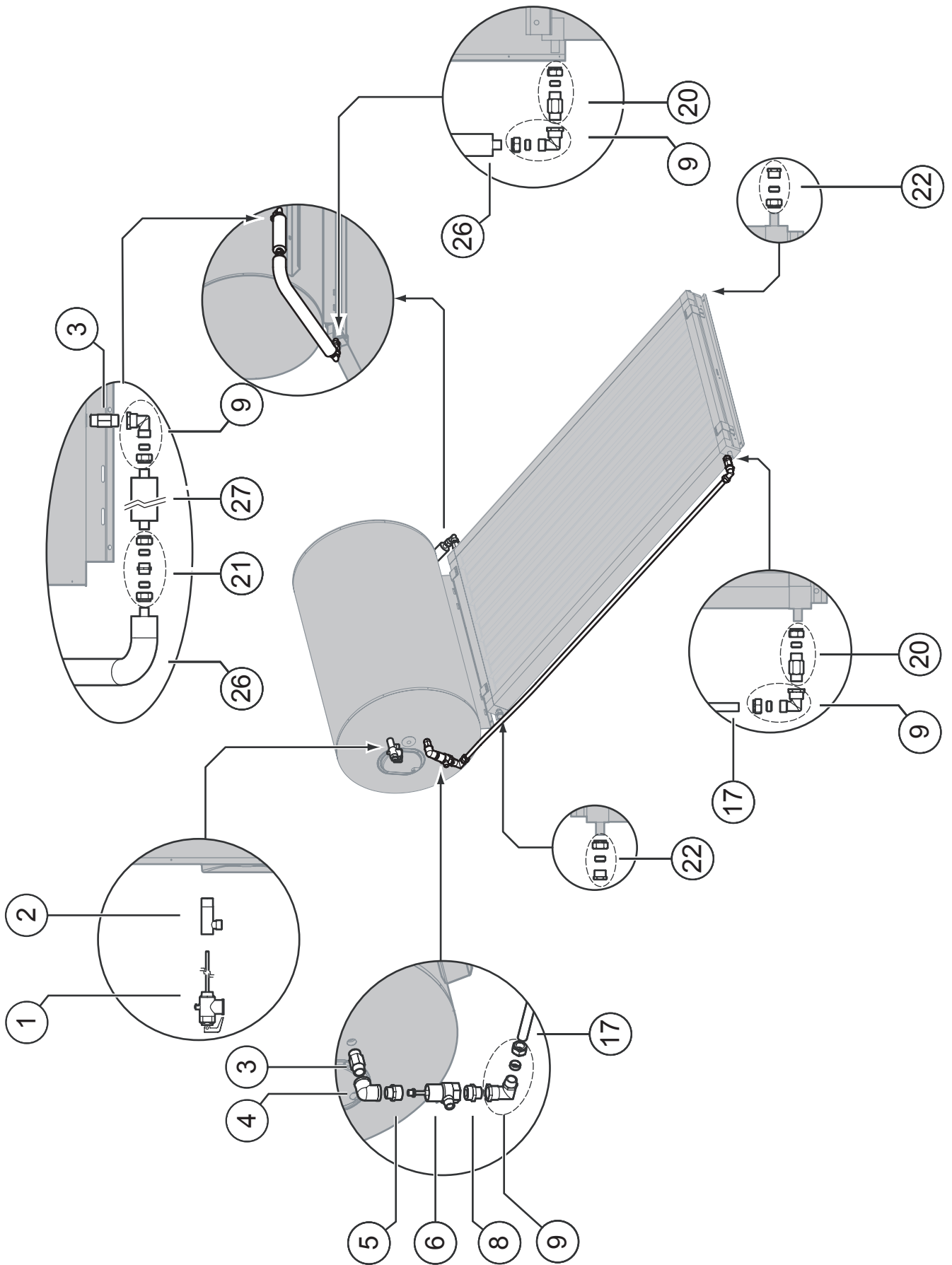



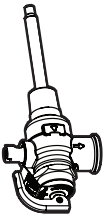
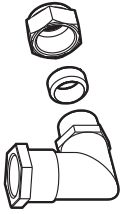

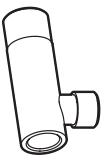

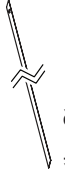







330 LITRE STAINLESS STEEL CYLINDER WITH 3 COLLECTORS - IKSUNICT23C

Qty	Item / Part Number	Qty	Item / Part Number	Qty	Item / Part Number
1	 P&TR Valve *supplied with cylinder 11004784	1	 Copper Pipe 31601774	2	 Mounting Rail Medium 14201197
1	 T adaptor hot outlet *supplied with cylinder 19001018	1	 Copper Pipe 1945mm 31601778	2	 Mounting Rail Large 14201198
1	 Reducing Nipple R1 x R 3/4 17201036	6	 Union Compression 3/4 - 1 nipple G 3/4 - 2 x Kinco nuts and olives 3/4 32201709	4	 Collector Mounting Straps supplied with collectors 12401012
1	 TA Valve 11007711	2	 Stop end assembly 28801025	2	 Cylinder Mounting Straps 12401013
1	 Adaptor M33 x R 3/4 16601096	1	 Union 3/4-compression to R - 1 x nipple G 3/4 x R 3/4 - 1 x Kinco nut and olive 3/4 32201713	4	 M8 Bolt Washer and Nut (used to bolt collector mounting strap to mounting rail) Bolt 22601052 Washer 17401072 Nut 16801062
1	 Elbow assembly Rp 3/4 x G 3/4 (Kinco) Elbow 21201026 Kinco Nut 16801018 Kinco Olive 3001011	1	 Copper Pipe with Insulation 31601751	12	 Collector Retainer 26601706
2	 Elbow assembly - 1 x Elbow G 3/4 (Kinco) x G 3/4 (Kinco) - 2 x Kinco nuts and olives 3/4 21201038	1	 Collector Joining Insulation - 3 x insulation, 3 x foil tape 33202053	12	 M6 Bolt Washer and Nut (used with collector retainers) Bolt 22601073 Washer 17401073 Nut 16801007
				1	 Operation and Installation Manual 15401022
				1	 Warranty Booklet 15401041
				1	 STC form 15401023

200 LITRE GLASS LINED CYLINDER WITH 1 COLLECTOR - IKV200CCT01C









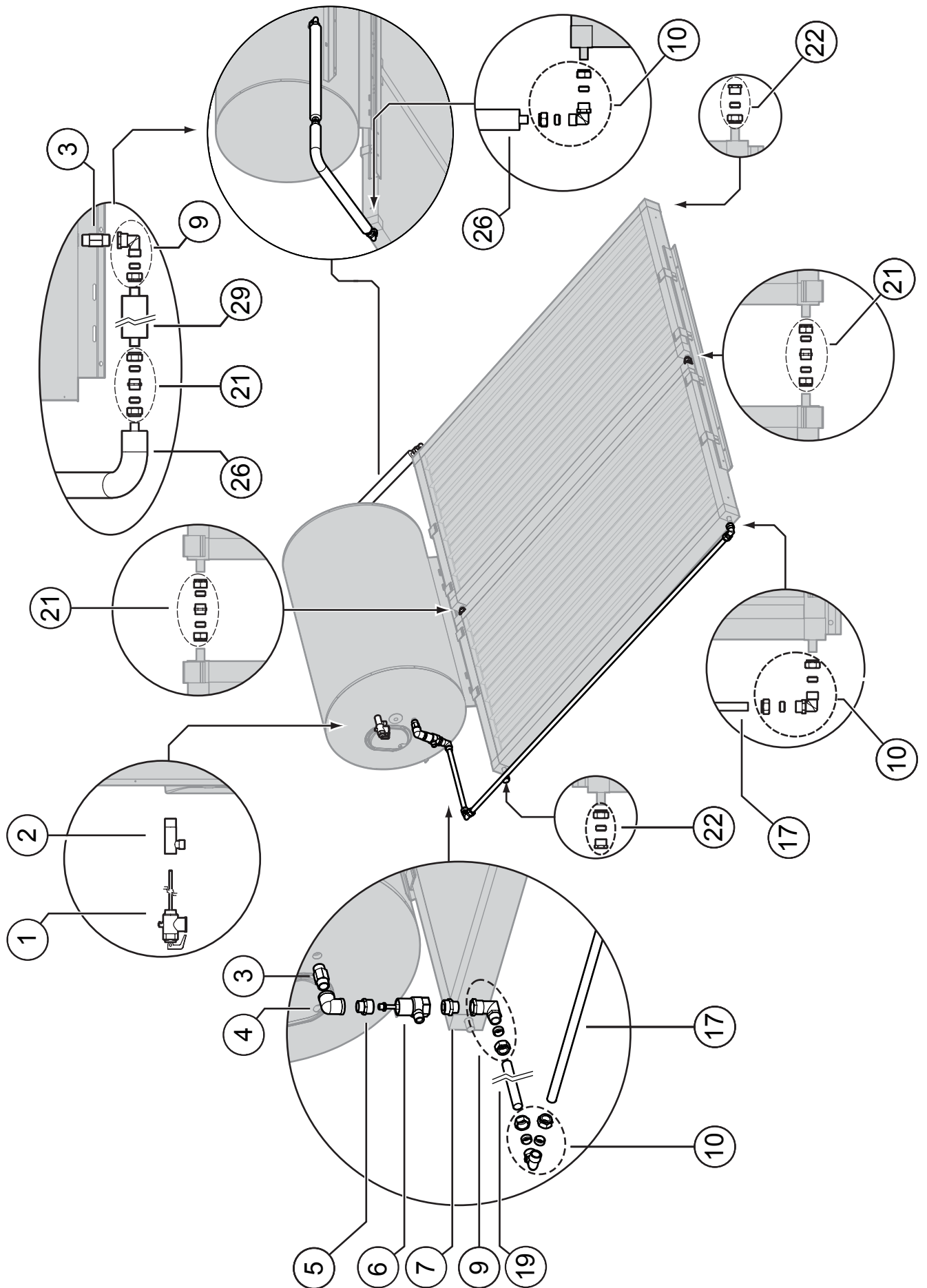



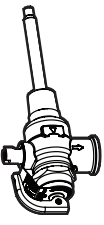
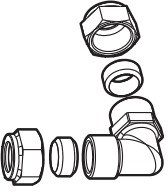

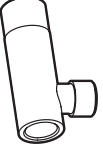

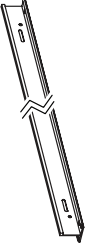

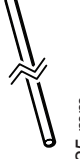
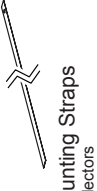

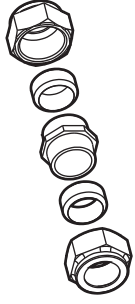



200 LITRE GLASS LINED CYLINDER WITH 1 COLLECTOR - IKV200CCT01C

Qty	Item / Part Number	Qty	Item / Part Number	Qty	Item / Part Number
1	 92501190 P&TR Valve *supplied with cylinder	4	 Elbow assembly Rp 3/4 x G 3/4 (Kinco) Elbow 21201026 Kinco Nut 16801018 Kinco Olive 3001011	-	 14201196 Mounting Rail Small
1	 92501117 T adaptor hot outlet *supplied with cylinder	1	 31601770 Copper Pipe 2100mm	-	 12401012 Collector Mounting Straps 2 with collector, 2 in kit
2	 17201011 R3/4 Nipple (long)	2	 16601097 Adaptor Assembly	-	 12401013 Cylinder Mounting Straps
1	 21201004 Elbow Rp 3/4 x Rp 3/4	1	 32201709 Union Compression 3/4 - 1 nipple G 3/4 - 2 x Kinco nuts and olives 3/4	-	 Bolt 22601052 Washer 17401072 Nut 16801062 (used to bolt collector mounting strap to mounting rail)
1	 17201036 Reducing Nipple R1 x R 3/4	2	 28801025 Stop end assembly	-	 26601706 Collector Retainer
1	 11007711 TA Valve	1	 31601764 Copper Pipe with Insulation	-	 Bolt 22601073 Washer 17401073 Nut 16801007 (used with collector retainers)
1	 16601096 Adaptor M33 x R 3/4	1	 31601767 Copper Pipe with Insulation	-	 15401022 Operation and Installation Manual
					 15401041 Warranty Booklet
					 15401023 STC form

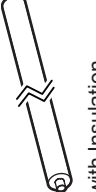
200 LITRE GLASS LINED CYLINDER WITH 2 COLLECTORS - IKVUNICCT23C

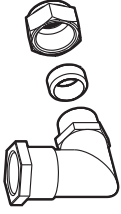







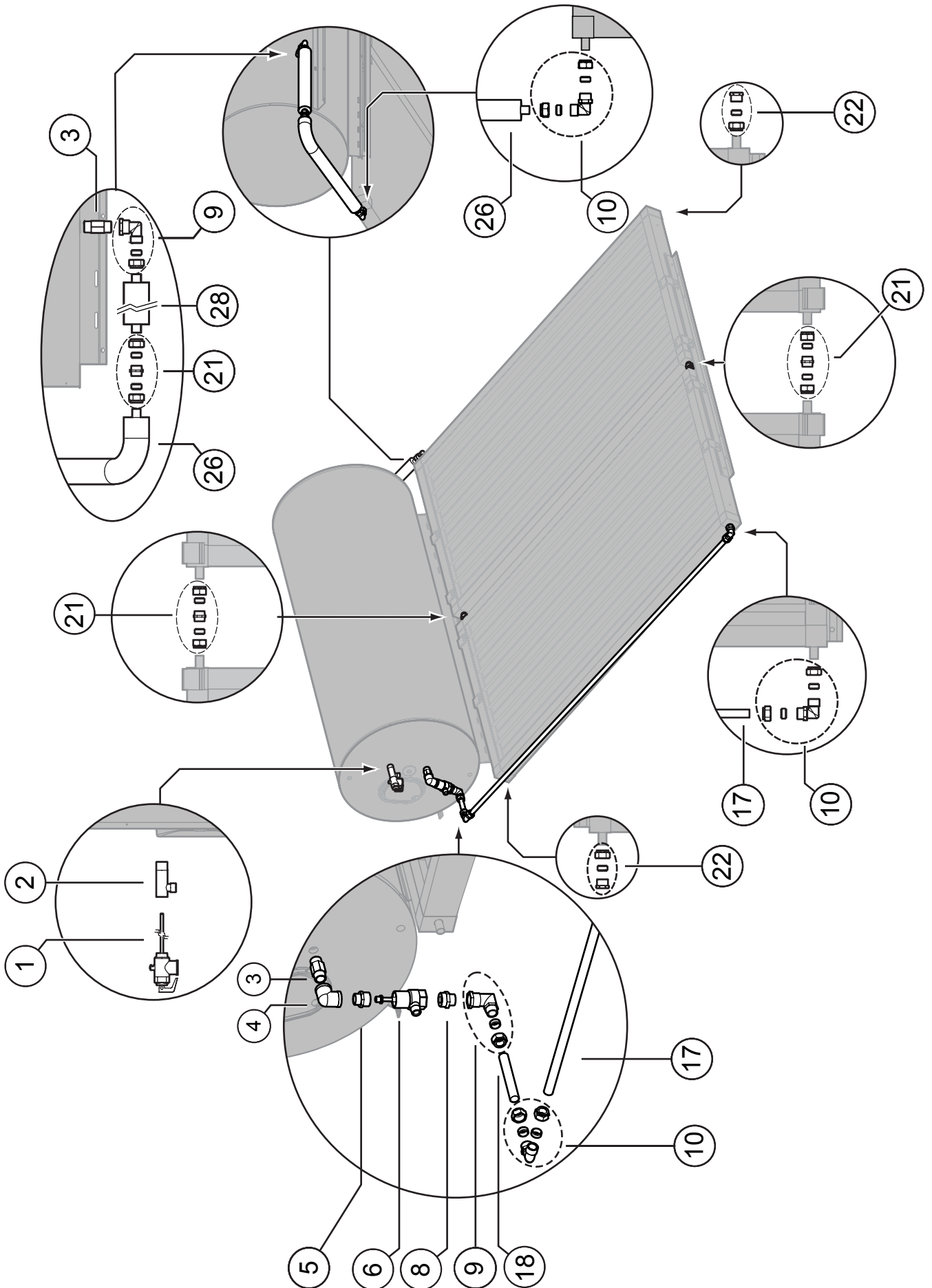



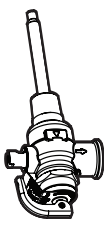
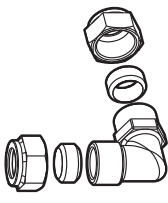





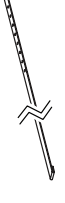

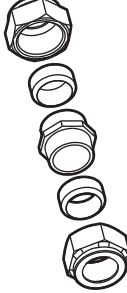



200 LITRE GLASS LINED CYLINDER WITH 2 COLLECTORS - IKVUNICCT23C

Qty	Item / Part Number	Qty	Item / Part Number	Qty	Item / Part Number
1	 P&TR Valve *supplied with cylinder 92501190	1	 Elbow assembly - 1 x Elbow G 3/4 (Kinco) x G 3/4 (Kinco) - 2 x Kinco nuts and olives 3/4 21201038	-	 Mounting Rail Medium 14201197
2	 T adaptor hot outlet *supplied with cylinder 92501117	1	 Copper Pipe 2100mm 31601770	-	 Mounting Rail Large 14201198
1	 R3/4 Nipple (long) 17201011	1	 Copper Pipe 725 mm (725 long - Installer to cut to 450) 31601780	-	 Collector Mounting Straps supplied with collectors 12401012
1	 Elbow Rp 1/2 x Rp 3/4 21201004	5	 Union Compression 3/4 - 1 nipple G 3/4 - 2 x Kinco nuts and olives 3/4 32201709	-	 Cylinder Mounting Straps 12401013
1	 Reducing Nipple R1 x R 3/4 17201036	2	 Stop end assembly 28801025	-	 M8 Bolt Washer and Nut (used to bolt collector mounting strap to mounting rail) Bolt 22601052 Washer 17401072 Nut 16801062
1	 TA Valve 11007711	1	 Copper Pipe with Insulation 31601764	-	 Collector Retainer 26601706
1	 Adeaptor M33 x R 3/4 16601096	1	 Copper Pipe with Insulation (870 long - Installer to cut to 670) 31601790	-	 M6 Bolt Washer and Nut (used with collector retainers) Bolt 22601073 Washer 17401073 Nut 16801007
2	 Elbow assembly Rp 3/4 x G 3/4 (Kinco) Kinco Nut 16801018 Kinco Olive 3001011	1	 Collector Joining Insulation - 3 x insulation, 3 x foil tape (1 of each not used) 33202053	-	 Operation and Installation Manual 15401022
					 Warranty Booklet 15401041
					 STC form 15401023

330 LITRE GLASS LINED CYLINDER WITH 2 COLLECTORS - IKV330CCT02C

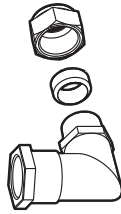







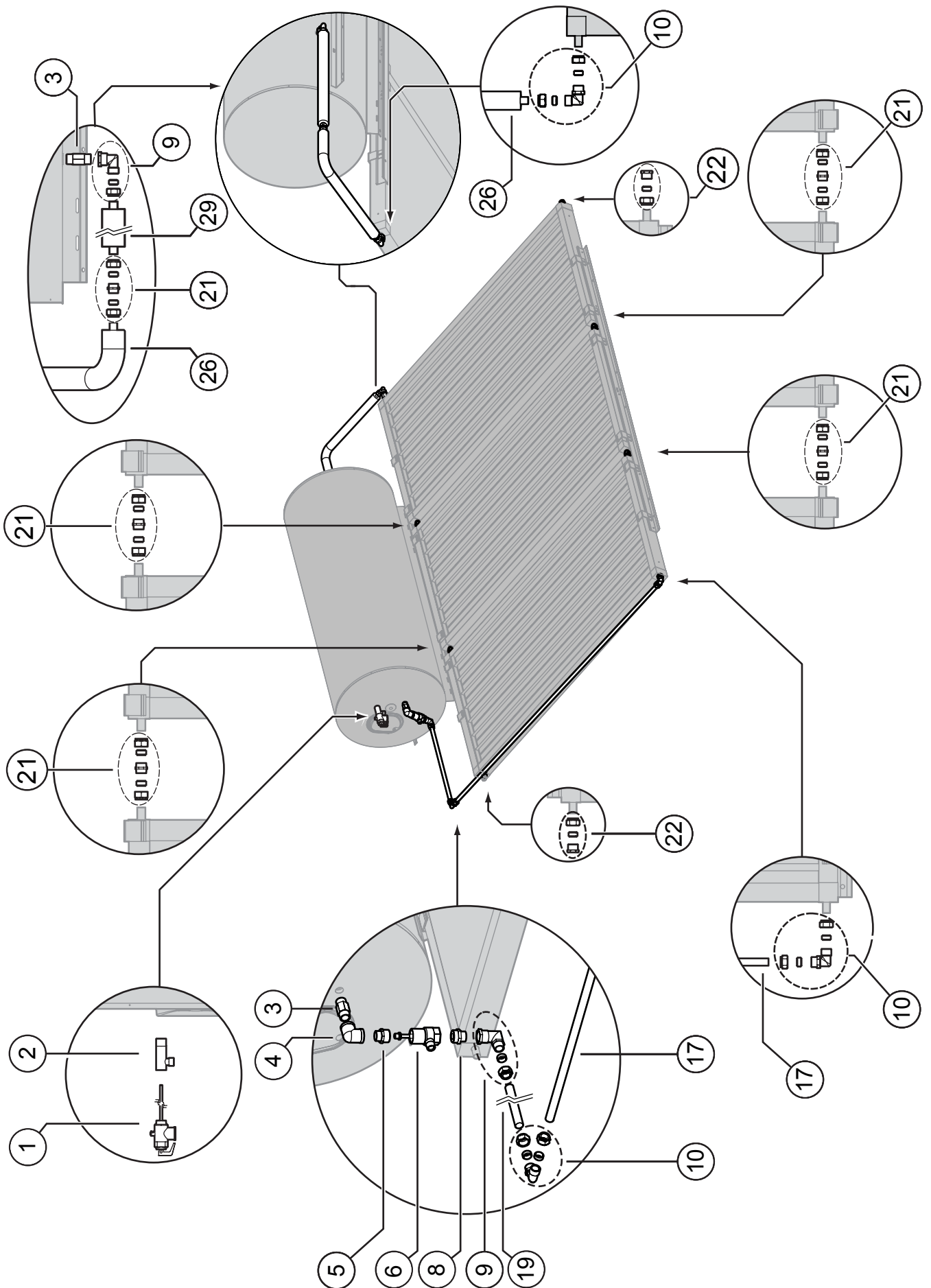



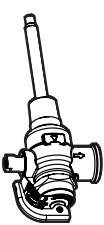
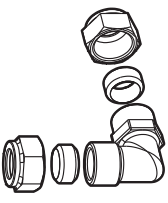

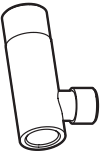
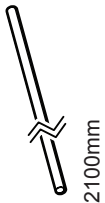
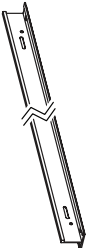

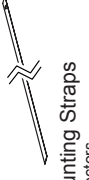

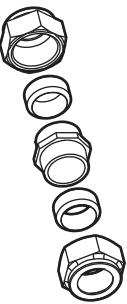
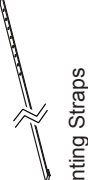



330 LITRE GLASS LINED CYLINDER WITH 2 COLLECTORS - IKV330CCT02C

Qty	Item / Part Number	Qty	Item / Part Number	Qty	Item / Part Number
(1)	1 P&TR Valve *supplied with cylinder 92501190 	-	3 Elbow assembly - 1 x Elbow G 3/4 (Kinco) x G 3/4 (Kinco) - 2 x Kinco nuts and olives 3/4 21201038 	-	2 Mounting Rail Medium 14201197 
(2)	1 T adaptor hot outlet 92501117 	(10)	1 Copper Pipe 2100mm 31601770 	-	4 Collector Mounting Straps supplied with collectors 12401012 
(3)	2 R3/4 Nipple (long) 17201011 	(17)	1 Copper Pipe 150 mm 31601771 	-	2 Cylinder Mounting Straps 12401013 
(4)	1 Elbow Rp 3/4 x Rp 3/4 21201004 	(18)	3 Union Compression 3/4 - 1 nipple G 3/4 32201709 	-	4 M8 Bolt Washer and Nut (used to bolt collector mounting strap to mounting rail) Bolt 22601052 Washer 17401072 Nut 16801062 
(5)	1 Reducing Nipple R1 x R 3/4 17201036 	(21)	2 Stop end assembly 28801025 	-	8 Collector Retainer 26601706 
(6)	1 TA Valve 11007711 	(22)	1 Copper Pipe with Insulation 31601764 	-	8 M6 Bolt Washer and Nut (used with collector retainers) Bolt 22601073 Washer 17401073 Nut 16801007 
(8)	1 Adaptor M33 x R 3/4 16601096 	(26)	1 Copper Pipe with Insulation 370 mm 31601765 	-	1 Operation and Installation Manual 15401022 
(9)	2 Elbow assembly Rp 3/4 x G 3/4 (Kinco) Elbow 21201026 Kinco Nut 16801018 Kinco Olive 3001011 	(28)	1 Collector Joining Insulation - 2 x insulation, 2 x foil tape 33202052 	-	1 Warranty Booklet 15401041 
		-		-	1 STC form 15401023 

330 LITRE GLASS LINED CYLINDER WITH 3 COLLECTORS - IKVUNICCT23C

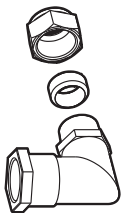

330 LITRE GLASS LINED CYLINDER WITH 3 COLLECTORS - IKVUNICCT23C

Qty	Item / Part Number	Qty	Item / Part Number	Qty	Item / Part Number
1	 P&TR Valve *supplied with cylinder 92501190	1	 Elbow assembly - 1 x Elbow G 3/4 (Kinco) x G 3/4 (Kinco) - 2 x Kinco nuts and olives 3/4 21201038	-	 Mounting Rail Medium 14201197
2	 T adaptor hot outlet *supplied with cylinder 92501117	1	 Copper Pipe 2100mm 31601770	-	 Mounting Rail Large 14201198
2	 R3/4 Nipple (long) 17201011	1	 Copper Pipe 725 mm 31601780	-	 Collector Mounting Straps supplied with collectors 12401012
1	 Elbow Rp 3/4 x Rp 3/4 21201004	5	 Union Compression 3/4 - 1 nipple G 3/4 - 2 x Kinco nuts and olives 3/4 32201709	-	 Cylinder Mounting Straps 12401013
1	 Reducing Nipple R1 x R 3/4 17201036	2	 Stop end assembly 28801025	-	 M8 Bolt Washer and Nut (used to bolt collector mounting strap to mounting rail) Bolt 22601052 Washer 17401072 Nut 16801062
1	 TA Valve 11007711	1	 Copper Pipe with Insulation 31601764	-	 Collector Retainer 26601706
1	 Adaptor M33 x R 3/4 16601096	1	 Copper Pipe with Insulation 31601779	-	 M6 Bolt Washer and Nut (used with collector retainers) Bolt 22601073 Washer 17401073 Nut 16801007
2	 Elbow assembly Rp 3/4 x G 3/4 (Kinco) Kinco Nut 21201026 Kinco Olive 16801018 3001011	1	 Collector Joining Insulation - 3 x insulation, 3 x foil tape 33202053	-	 Operation and Installation Manual 15401022
				-	 Warranty Booklet 15401041
				-	 STC form 15401023

INSTALLATION - GAS BOOSTED SYSTEMS

GAS BOOSTER LOCATION

The S20, S26 and S32 gas boosters are designed for 'Outdoor' Installation only. As such, they must be located in an above ground open air situation with natural ventilation, without stagnant areas, where gas leakage and products of combustion are rapidly dispersed by wind and natural convection. The location must comply with the clearances specified in AS/NZS 5601.

The gas booster must be mounted on a vertical structure with the water and gas connections on the underside pointing downwards. The heated outlet of the cylinder is connected to cold water inlet of the gas booster.

Ensure that the wall or structure on which it is to be mounted are capable of supporting the weight of the appliance and associated pipe work. See page 16 for individual gas booster weights. For gas boosters installed on elevated structures or under floors specific requirements apply.

Refer to AS/NZS 5601 for details.

- Attach the gas booster to the wall using screws.
- Location of the gas booster flue terminal must be in accordance with Figure 6.2 of AS/NZS 5601.

If an internal model which has been converted to a solar gas booster follow information supplied with the unit for location, mounting and flueing requirements.

GAS SUPPLY

The maximum gas consumption of the gas booster and the required gas pressure are shown on the appliance data plate. If the gas pipe sizing is insufficient the customer will not get the full performance benefit.

Gas pipe sizing must consider the gas input to the gas booster as well as all the other gas appliances on the premises. The gas meter and regulator must be specified for this gas rate. An approved sizing chart such as the one in AS/NZS 5601 should be used.

An approved full flow isolation valve and disconnection union must be fitted to the gas supply inlet of the gas booster. Isolation valves must not be fitted directly to the booster.

HOT WATER DELIVERY TEMPERATURE

Gas boosters for use in solar hot water systems are preset to deliver a fixed temperature of 70°C in accordance with plumbing regulations. In addition, they contain the warning stating "Rinnai Water Controllers are NOT compatible with solar hot water installations and MUST NOT BE USED in the vicinity of the temperature controller connections inside the appliance."



Gas Boosters other than models designated "S20", "S26", "S26i", "S32" or "Solar" must not be used. Gas Boosters marked with the text: "THIS APPLIANCE DELIVERS WATER NOT EXCEEDING 50°C IN ACCORDANCE WITH AS 3498" are incompatible with solar hot water systems and must not be used.

SMARTSTART®

The Smartstart® is a separate system that works in conjunction with the Rinnai solar hot water system.

When activated by the manual activation switch, water in the pipework connected between the solar hot water system and the hot water outlets is warmed before any outlets are opened. This results in water savings and added convenience. Refer to page 49 for installation details.

SYSTEM USING RINNAI SMARTSTART

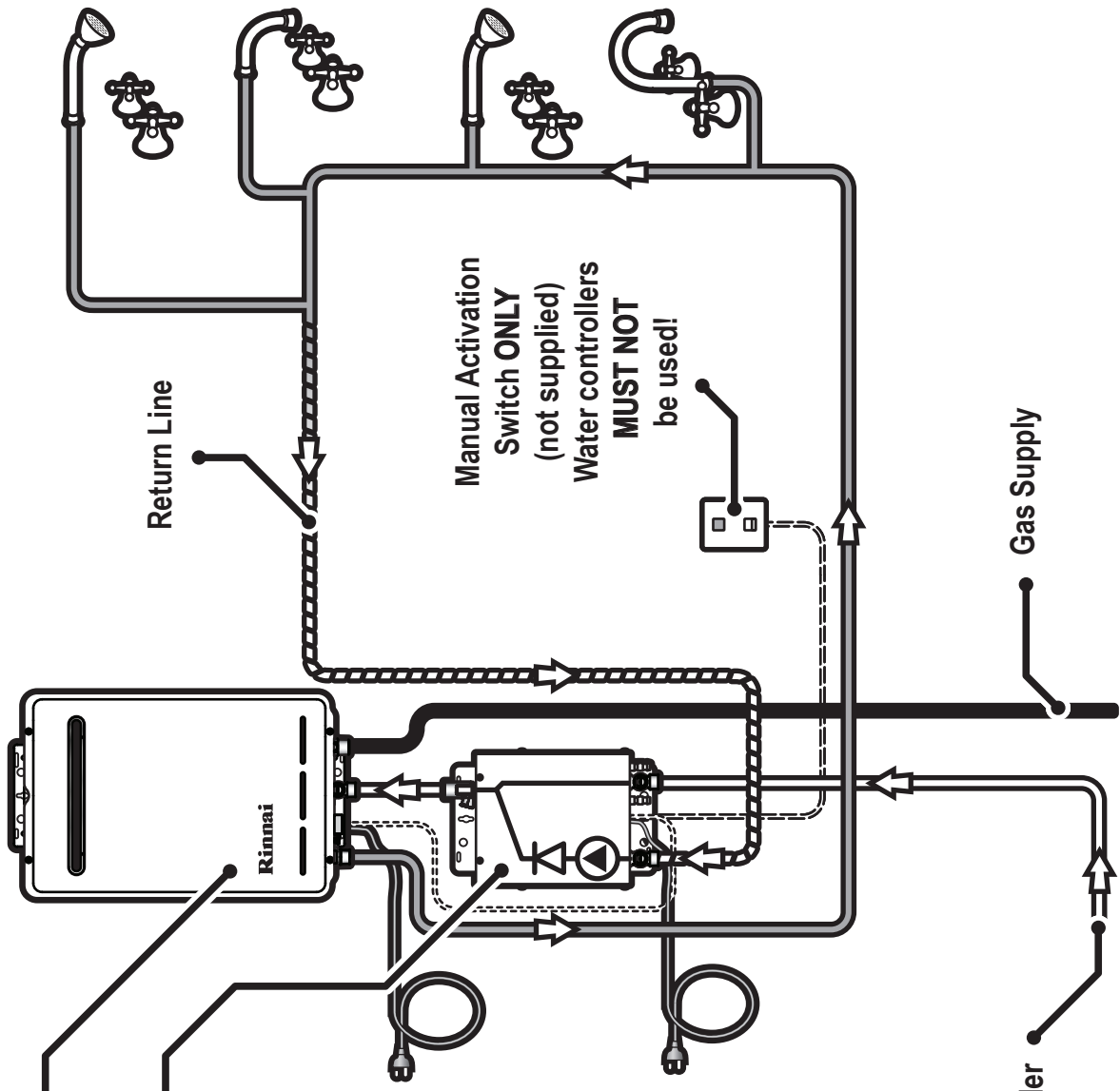

! IMPORTANT

Outlets to Personal Hygiene areas to be tempered to 50°C as per AS/NZS 3500.4

Refer to Rinnai manuals supplied with appliances for important installation information.

Installations **MUST** conform to local regulations.

Rinnai Continuous Flow Water Heater - Gas Booster

Rinnai Smartstart Unit

Gas Supply

Supply from solar storage cylinder

GAS BOOSTER CLEARANCES

Figure 6.2 from AS/NZS5601 is reproduced below. It was current at the time of printing, but may have been superseded. It is the installer's responsibility to ensure that current requirements are met.

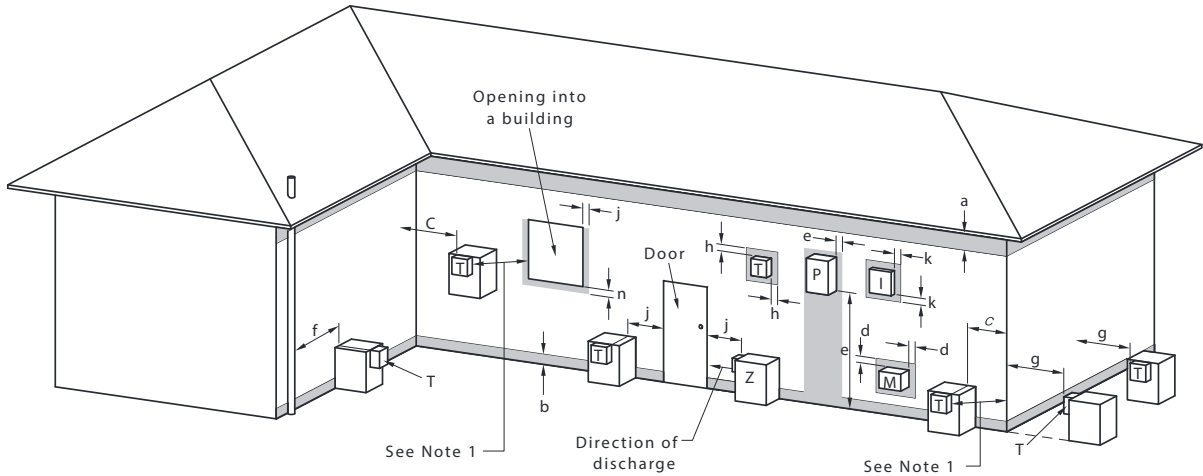

I = Mechanical air inlet M = Gas meter P = Electricity meter or fuse box T = Flue terminal Z = Fan-assisted appliance only

Shading indicates prohibited area for flue terminals

Ref.	Item	Min. clearances (mm)
		Fan assisted
Below eaves, balconies and other projections:		
a	• Appliances up to 50 MJ/h input	200
	• Appliances over 50 MJ/h input	300
b	From the ground, above a balcony or other surface *	300
c	From a return wall or external corner *	300
d	From a gas meter (M) (see Note 5) (See Clauses 5.11.5.9 for vent terminal location of regulator) (See Table 6.7 for New Zealand requirements)	1000
e	From an electricity meter or fuse box (P) † (see Note 5)	500
f	From a drain pipe or soil pipe	75
g	Horizontally from any building structure* or obstruction facing a terminal	500
h	From any other flue terminal, cowl, or combustion air intake *	300
Horizontally from an openable window, door, non-mechanical air inlet, or any other opening into a building with the exception of sub-floor ventilation:		
j	• Appliances up to 150 MJ/h input *	300
	• Appliances over 150 MJ/h input up to 200 MJ/h input *	300
	• Appliances over 200 MJ/h input up to 250 MJ/h input *	500
	• Appliances over 250 MJ/h input *	1500
	• All fan-assisted flue appliances, in the direction of discharge	1500
k	From a mechanical air inlet, including a spa blower	1000
Vertically below an openable window, non-mechanical air inlet, or any other opening into a building with the exception of sub-floor ventilation:		
n	• Space heaters up to 50 MJ/h input	150
	• Other appliances up to 50 MJ/h input	500
	• Appliances over 50 MJ/h input and up to 150 MJ/h input	1000
	• Appliances over 150 MJ/h input	1500

* - unless appliance is certified for closer installation.

† - Prohibited area below electricity meter or fuse box extends to ground level.

NOTES:

- Where dimensions c, j or k cannot be achieved an equivalent horizontal distance measured diagonally from the nearest discharge point of the terminal to the opening may be deemed by the Technical Regulator to comply.
- See Clause 6.9.4 for restrictions on a flue terminal under a covered area.
- See Figure J3 for clearances required from a flue terminal to an LP Gas cylinder. A flue terminal is considered to be a source of ignition.
- For appliances not addressed above acceptance should be obtained from the Technical Regulator.
- Minimum clearances d and e also apply to any combustion air intake openings of appliances.

FIGURE 6.2 (in-part) LOCATION OF FLUE TERMINALS OF BALANCED FLUE, ROOM SEALED, FAN-ASSISTED OR OUTDOOR APPLIANCES

INSTALLATION PROCEDURE

1. Install Solar Collectors and cylinders

Position and install the solar collectors and cylinder in accordance with the section ‘Standard Installation’ on page 24.

2. Connect PTR Valve

Connect the PTR Valve in the location shown in the relevant diagram on pages 32 to 47. Leave the valve outlet pointing down. Tighten the valve using the spanner flats - never use the valve body.

The PTR Valve must be adequate for the thermal loading applied to the storage cylinder. In the case of gas boosted systems, the thermal load is applied only by the solar collectors. The continuous flow hot water heater does not apply thermal load to the storage cylinder. The potential solar output for the solar collectors at PTR Valve relief conditions is listed on page 15.

The PTR Valve pressure ratings vary according the cylinder specifications. The maximum heater input rating is 10.0 kW. The PTR valve rating **MUST EXCEED** the total input from the solar collectors. If it does not, the PTR valve **MUST** be exchanged for a model of higher capacity.

For example, for a gas boosted solar system with 3 x SP200A collectors, the thermal load is 3 x 1.25 = 3.75 kW. This is less than 10.0 kW, hence the supplied PTR valve is of sufficient capacity.

Use Teflon thread tape on the valve, never use hemp or other sealing materials. Ensure the tape does not protrude past the end of the thread, which could result in it hanging over the end of the thread and blocking the water passage through the valve.

3. Mount Gas Booster

Mount the gas booster in accordance with the section ‘Gas Booster Location’ on page 48.

4. Connect Water to Gas Booster

Connect the outlet of the storage cylinder to the water inlet of the gas booster.

5. Connect Fittings

Connect fittings and pipe work as shown in the relevant diagram on pages 32 to 47.

6. Cold Water Supply

Connect cold water supply to the T/A valve inlet. Ensure that the relevant valves are fitted as described in the section ‘Valves and Fittings’ on page 19.

Purge the cold water supply lines to remove air and swarf before final connection.

7. Relief Drain Lines

Independent 15 mm copper pipes must be fitted to the drain outlets of the PTR and ECV. Each pipe must be open to atmosphere and run with a continual downward grade in a frost free environment to a visible discharge point. Drain lines must not exceed 9 metres in length.

Valves or other restrictions must not be placed in the relief valve drain outlet line.



Some water will drip from the drain lines during heating of the water in the storage cylinder. It is recommended to discharge directly above a drain.

8. Hot Water Discharge

Connect the hot water outlet of the gas booster to the pipe work supplying hot water to the premises.



A temperature limiting device may be required as detailed in the section ‘Hot Water Delivery Temperature’ on page 19.

9. Connect Gas to Booster

Connect a suitable gas supply and isolating valve to the gas booster. Follow instructions supplied with gas booster. Keep gas booster isolated at this stage.

FILLING THE SYSTEM



Ensure building occupants are warned to stay clear of the solar system components, building perimeter and roof since hot water or steam may be discharged from pipes or components.

1. Ensure the gas supply to the continuous flow water heater is isolated.
2. Turn 'ON' the hot water tap at the sink. Open the stop cock in the cold water mains supply line.
3. The entire system will now be filled with cold water. Most air will be dispelled through the tap. Some air needs to be bled from the air bleed valve on the collectors.
4. Turn 'OFF' the hot tap at the sink when water flows freely without air bubbles or air bursts. Check all connections for leakage and tighten if necessary. This applies especially to fittings in positions not easily accessed such as near the solar collectors. Operate the easing gear of both the PTR and ECV valves at the storage cylinder to ensure these valves are functional.



If leaks are detected the system must be drained and leaks repaired before the system is refilled. If this is necessary, cover the solar collectors with packaging cardboard or a tarp to prevent them from heating which could result in steam or hot water being discharged from fittings..

PRE SOLAR HEATING CHECKS

Before commencing solar heating of the water in the system ensure the following actions have been completed:

Solar Collectors and Cylinder

1. Are the solar collectors installed with the correct slope and orientation to the sun?
2. Is the installation finished neatly with the roof made good, all tiles and flashings in place?
3. Are the bolts tight on the roof framework?
4. Are all solar collector and cylinder straps fitted and correctly anchored to the roof structure?
5. If leak testing completed and successful, have any covers been removed from the solar collectors?

Gas Booster

1. Ensure the gas supply is isolated. Remove the test point screw located on the gas inlet connection and attach a pressure gauge.
2. Turn on the electrical power to the gas booster and turn on the gas supply.
3. Ensure the cold water inlet ('trio') valve on the storage cylinder inlet is open. Open all available hot water taps.
4. Operate ALL other gas appliances at their maximum gas rate, in accordance with manufacturers instructions.



Ensure building occupants do not have access to hot water outlets during this procedure.

5. With all gas appliances in operation at the maximum gas rate, the pressure should read between 1.13 - 3.0 kPa on Natural Gas. On LPG the pressure should be 2.75 - 3.0 kPa. If the pressure is lower, the gas supply is inadequate and the appliance will not operate to specification.

It is the installers responsibility to check the gas meter, service regulator and pipe work for correct operation/ sizing & rectify as required. Note that the gas regulator on the appliance is electronically controlled and factory pre-set. Under normal circumstances it DOES NOT need adjustment during installation. Make adjustments only if the gas booster is not operating correctly and all other possible causes for incorrect operation have been eliminated. Instructions for gas pressure setting are located in the pocket behind the front cover of the gas booster.

6. Close the hot water taps including the shower.
7. Close the cold water inlet ('trio') valve on the storage cylinder inlet and inspect and clean the strainer. Repeat for the strainer connected at the inlet of the gas booster. This procedure may need to be repeated to ensure the strainers remains clear, especially on new installations.
8. Confirm the hot water delivery temperature from the gas booster. This is done by checking the hot water delivery temperature at an untempered outlet close to the water heater. This is usually the hot water outlet in the kitchen. The untempered hot water delivery should be between 65°C & 70°C.

Temperature Limiting Devices

1. Commission any temperature limiting devices in accordance with the instructions supplied by the manufacturer.
2. Confirm the hot water delivery temperature at a tempered water outlet. Tempered water outlets should be those supplying areas primarily used for the purposes of personal hygiene such as bathrooms. The hot water delivery temperature should not exceed 50°C or 45°C as detailed in the section 'Hot Water Delivery Temperature' on page 19.

SOLAR HEATING

1. Remove any cardboard or tarp covers that may have been placed over the solar collectors to prevent them from heating water during installation and commissioning. Solar heating of the water in the cylinder will now commence when sufficient solar radiation is available.
2. Activate electrical power to both the gas booster.

FINISHING THE INSTALLATION

1. After testing is completed explain to the householder the functions and operation of solar water heater components and the importance of carrying out Maintenance as per separate warranty document.
2. Complete the installation record at the back of the manual.
3. Leave this manual and the warranty booklet with the householder.

DRAINING INSTRUCTIONS

1. The power supply to the gas booster must be switched off.
2. Close the cold water mains supply stop cock.
3. Open a hot tap to relieve pressure.
4. Disconnect the cold water connection to the Thermo-arrest (T/A) valve.
5. Remove the brass plug on the bottom right hand side of the collector bank.
6. Disconnect the 'water inlet' and 'water outlet' connections at the gas booster.
7. The system will now drain all water.

INSTALLATION - ELECTRIC BOOSTED SYSTEMS

INSTALLATION PROCEDURE

1. Install Solar Collectors and Cylinders

Position and install the solar collectors and cylinder in accordance with the section 'Standard Installation' on page 24.

2. Connect PTR Valve

Connect the PTR Valve in the location shown in the relevant diagram of pages 32 to 47. Leave the valve outlet pointing down. Tighten the valve using the spanner flats - never use the valve body.

The PTR Valve must be adequate for the thermal loading applied to the storage cylinder. In the case of gas boosted systems, the thermal load is applied only by the solar collectors. The continuous flow hot water heater does not apply thermal load to the storage cylinder. The potential solar output for the solar collectors at PTR Valve relief conditions is listed in page 15.

The PTR Valve pressure ratings vary according to the cylinder specifications. The maximum heater input rating is 10.0 kW. The PTR valve rating **MUST EXCEED** the total input from the solar collectors. If it does not, the PTR valve **MUST** be exchanged for a model of higher capacity.

For example, for a gas boosted solar system with 3 x SP200A collectors, the thermal load is $3 \times 1.25 = 3.75$ kW. This is less than 10.0 kW, hence the supplied PTR valve is of sufficient capacity.

Use Teflon thread tape on the valve, never use hemp or other sealing materials. Ensure the tape does not protrude past the end of the thread, which could result in it hanging over the end of the thread and blocking the water passage through the valve.

3. Connect Fittings

Connect fittings and pipe work as shown in the relevant diagram on pages 32 to 47.

4. Cold Water Supply

Connect cold water supply to the T/A valve inlet. Ensure that the relevant valves are fitted as described in the section 'Valves and Fittings' on page 19.

Purge the cold water supply lines to remove air and swarf before final connection.

5. Relief Drain Lines

Independent 15 mm copper pipes must be fitted to the drain outlets of the PTR and ECV. Each pipe must be open to atmosphere and run with a continual downward grade in a frost free environment to a visible discharge point. Drain lines must not exceed 9 metres in length.

Valves or other restrictions must not be placed in the relief valve drain outlet line.



Some water will drip from the drain lines during heating of the water in the storage cylinder. It is recommended to discharge directly above a drain.

6. Hot Water Discharge

Connect the hot water outlet of the gas booster to the pipe work supplying hot water to the premises.



A temperature limiting device may be required as detailed in the section 'Hot Water Delivery Temperature' on page 19.

7. Electric Supply



The power supply to the heating elements must not be activated until the system is filled with water.

Wiring of Electric Element

The power supply to the element of the solar storage cylinder can be Off-Peak (overnight), Extended Off-Peak (overnight and day), continuous or other tariffs available from the local electricity supply authority. Rinnai strongly recommends the use of an off-peak tariff to ensure that solar heating takes priority over electrical heating. If this tariff isn't available, then a timer can be used to limit electrical heating to non solar hours.

A flexible 20 mm conduit is required for the electrical cable to the storage cylinder. The conduit is to be connected to the unit with a 20 mm terminator. Connect the power supply wires directly to the terminal block and earth tab connections ensuring there are no excess wire loops inside the front cover.

Heating Element Thermostat Temperature Settings

Australian Standards require a minimum thermostat set point of 60°C to inhibit the growth of Legionella Pneumophilia bacteria. In the interests of durability, the thermostat set point for storage cylinders should not exceed 70°C. Hence, the thermostat set point should be at least 60°C and no greater than 70°C.

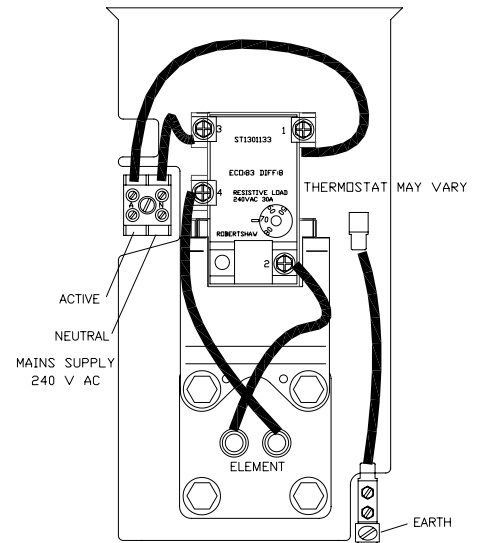

FILLING THE SYSTEM



Ensure building occupants are warned to stay clear of the solar system components, building perimeter and roof since hot water or steam may be discharged from pipes or components.

1. Ensure the electric power supply to the water heater is switched 'OFF'.
2. Turn 'ON' the hot water tap at the sink. Open the stop cock in the cold water mains supply line.
3. The entire system will now be filled with cold water. Most air will be dispelled through the tap. Some air will need to be bled from the air bleed valve on the collectors.
4. Turn 'OFF' the hot tap at the sink when water flows freely without air bubbles or air bursts. Check all connections for leakage and tighten if necessary. This applies especially to fittings in positions not easily accessed such as near the solar collectors. Operate the easing gear of both the PTR and ECV valves at the storage cylinder to ensure these valves are functional.



If leaks are detected the system must be drained and leaks repaired before the system is refilled. If this is necessary, cover the solar collectors with packaging cardboard or a tarp to prevent them from heating which could result in steam or hot water being discharged from fittings..

PRE SOLAR HEATING CHECKS

Before commencing solar heating of the water in the system ensure the following actions have been completed:

Solar Collectors and Cylinder

1. Are the solar collectors installed with the correct slope and orientation to the sun?
2. Is the installation finished neatly with the roof made good, all tiles and flashings in place?
3. Are the bolts tight on the roof framework?
4. Are all solar collector and cylinder straps fitted and correctly anchored to the roof structure?
5. If leak testing completed and successful, have any covers been removed from the solar collectors?

Electric Heating Element

1. Has the thermostat set point been set to at least 60°C and no greater than 70°C?

Temperature Limiting Devices

1. Commission any temperature limiting devices in accordance with the instructions supplied by the manufacturer.
2. Confirm the hot water delivery temperature at a tempered water outlet. Tempered water outlets should be those supplying areas primarily used for the purposes of personal hygiene such as bathrooms. The hot water delivery temperature should not exceed 50°C or 45°C as detailed in the section 'Hot Water Delivery Temperature' on page 19.

SOLAR HEATING

1. Remove any cardboard or tarp covers that may have been placed over the solar collectors to prevent them from heating water during installation and commissioning. Solar heating of the water in the cylinder will now commence when sufficient solar radiation is available.
2. Activate electrical power to both the gas booster.

FINISHING THE INSTALLATION

1. After testing is completed explain to the householder the functions and operation of solar water heater components and the importance of carrying out Maintenance as per separate warranty document.
2. Complete the installation record at the back of the manual.
3. Leave this manual and the warranty booklet with the householder.

DRAINING INSTRUCTIONS

1. The power supply to the gas booster must be switched off.
2. Close the cold water mains supply stop cock.
3. Open a hot tap to relieve pressure.
4. Disconnect the cold water connection to the Thermo-arrest (T/A) valve.
5. Remove the brass plug on the bottom right hand side of the collector bank.
6. Disconnect the 'water inlet' and 'water outlet' connections at the gas booster.
7. The system will now drain all water.

INSTALLATION RECORD

Installer Details

Installers Name: _____

Company Name: _____

Company Address: _____

Company Contact Details

Telephone: _____

Mobile Phone: _____

Certificate of Compliance / Certification Number: _____

Authorised Persons - Licence Number: _____

Installers Signature: _____

Installation Date: _____

System Details

Storage Cylinder Model Number : _____

Serial Number: _____

Solar Collector(s) Model Number : _____

Serial Number: _____

Gas Booster Model Number : _____

Serial Number: _____

Installation Address: _____

NOTES



A series of horizontal lines spaced evenly down the page, providing a template for handwritten notes.

Rinnai

Rinnai Australia Pty. Ltd. ABN 74 005 138 769

Head Office

100 Atlantic Drive,
Keyborough, Victoria 3173

Tel: (03) 9271 6625
Fax: (03) 9271 6622

P.O. Box 460
Braeside, Victoria 3195

Rinnai has a Service and Spare Parts network with personnel who are fully trained and equipped to give the best service on your Rinnai appliance. If your appliance requires service, please call our National Help Line. Rinnai recommends that this appliance be serviced every 3 years.

Internet: www.rinnai.com.au E-mail: enquiry@rinnai.com.au

National Help Line

Tel: 1300 555 545* Fax: 1300 555 655*

**Cost of a local call higher from mobile or public phones.*

Hot Water Service Line

Tel: 1800 000 340

